



FCS-3081

H.264 2-Megapixel PoE Vandal Dome Camera



User Manual

Ver1.3

Table of Contents

1. Introduction.....	3
1.1 Features	3
1.2 Package Contents	4
1.3 Camera Overview	5
1.4 Camera's Connectors.....	6
2. Preparations for IP Camera Setup	7
2.1 System Requirements	7
2.2 Installation	7
5.1 Power and Ethernet Cable Connection	7
5.2 Hard Ceiling.....	8
5.3 4S Mount Electrical Box.....	13
3. Accessing Camera.....	16
Using recording software.....	20
Installing DC Viewer Software Online.....	21
4. Configuration & Operation.....	23
4.1 Browser-based Viewer Introduction	23
4.2 Home Page.....	24
4.3 System Related Settings.....	26
4.3.1 Host Name and System Time Setting.....	28
4.3.2 Security	29
4.3.3 Network.....	32
4.3.4 DDNS.....	37
4.3.5 Mail	38
4.3.6 FTP	39
4.3.7 Application (Excluding Compact IP Dome)	40
4.3.8 Motion Detection	45
4.3.9 Storage Management.....	49
4.3.10 Recording.....	51
4.3.11 File Location.....	52
4.3.12 Iris Adjustment (Excluding Compact IP Dome)	53
4.3.13 View Log File.....	54
4.3.14 View User Information	55
4.3.15 View Parameters.....	57
4.3.16 Factory Default.....	58
4.3.17 Software Version.....	59
4.3.18 Software Upgrade	60
4.3.19 Maintenance.....	63
4.4 Video and Audio Streaming Settings	64

4.4.1	Video Resolution and Rotate Type	64
4.4.2	Video Compression	67
4.4.3	Video OCX Protocol	69
4.4.4	Video Frame Skip.....	70
4.4.5	Video Mask.....	71
4.4.6	Audio Mode and Bit Rate Settings.....	72
4.5	Camera Settings.....	74
4.5.1	Exposure Setting.....	75
4.5.2	White Balance Setting.....	76
4.5.3	Brightness Setting	77
4.5.4	Sharpness Setting.....	77
4.5.5	Contrast Setting	77
4.5.6	Saturation Setting.....	77
4.5.7	Hue Setting	78
4.5.8	IR Function.....	78
4.5.9	TV System Setup	78
4.6	Logout	79
Appendix A: Technical Specifications		80
Appendix B: Internet Security Settings		81
Appendix C: DC Viewer Download Procedure		85
Appendix D: Install UPnP Components		87

Default ID / Password

Login ID	Password
root	

1. Introduction

The Full HD Vandal Proof IP Dome Camera is capable of serving real-time streaming and makes image quality more smoothly. In addition to MJPEG real time streaming, this camera develops H.264 codec to apply for high resolution digital broadcast.





With compact and sophisticated mechanical design, the Full HD Vandal Proof IP Dome Camera is easy installed and aesthetic. Additionally, the IP Dome Camera's vandal proof cover can protect the camera from heavy damage.

1.1 Features

- Progressive Scan CMOS Sensor
- Full HD 1080p / HD 720p real-time at dual streaming
- H.264 and MJPEG compression
- Motion Detection
- Privacy Masks
- Day/Night (ICR)
- Micro SD/SDHC support
- BNC analog output
- Weatherproof (IP66 international)
- Vandal proof dome cover
- ONVIF Support

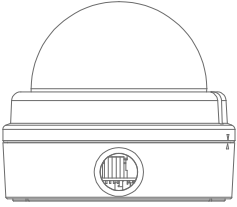
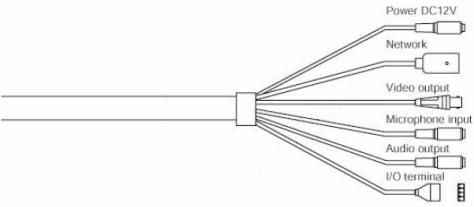
1.2 Package Contents

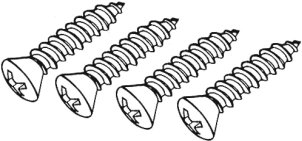
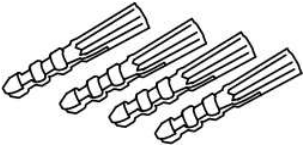
Please check the package contains the following items listed below.

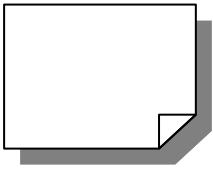
 <p>Vandal Proof IP Dome Camera</p>	 <p>All-in-One cable</p>	
 <p>Power Terminal Block</p>	 <p>Security Torx</p>	
 <p>Self Tapping Screws (x4)</p>	 <p>Plastic Screw Anchors (x4)</p>	 <p>Rubber Washers (x6)</p>
 <p>CD (bundled software and documentation)</p>	 <p>Quick Guide</p>	

1.3 Camera Overview

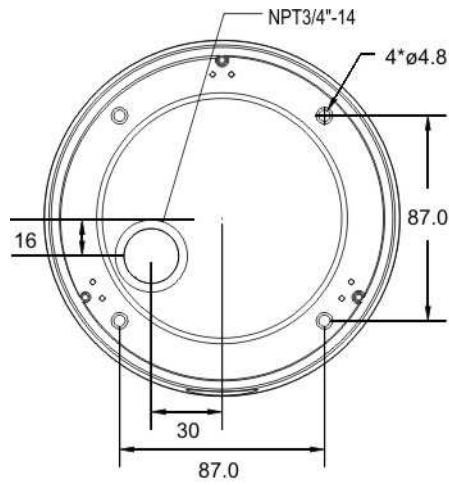

Top View

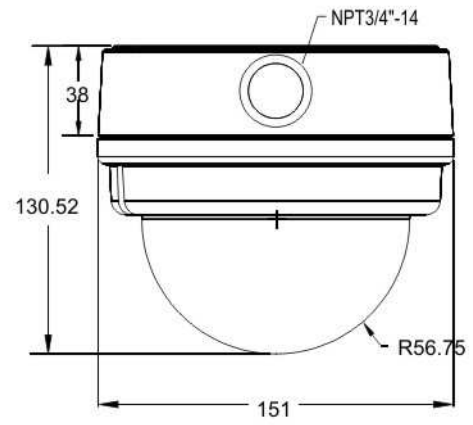

Side View

Unit: mm

1.4 Camera's Connectors

The diagram below shows the IP Dome Camera's reset button and various connectors. Definition for each connector will be given as follows.

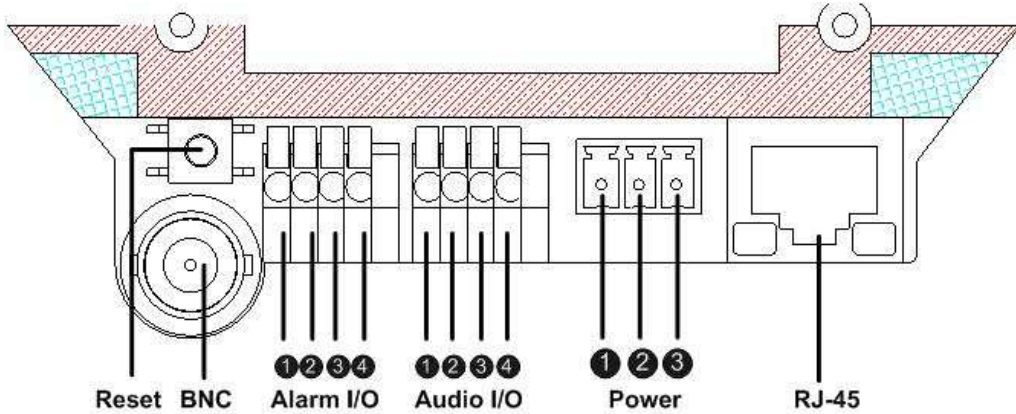

Connector		Pin No.	Definition	Remarks
Reset Button		-	Restore to factory default	
BNC		-	Analog Video Output	
Alarm I/O		1	Output +	Alarm connection
		2	Output -	
		3	Input +	
		4	Input -	
Audio I/O		1	Input	Two-way audio transmission
		2	GND	
		3	Output (R)	
		4	Output (L)	
Power	DC 12V	1	Power	Power connection
		2	Reserved	
		3	GND	
	AC 24V	1	Power-1	
		2	Earth GND	
		3	Power-2	
RJ-45		-	10/100 Mbps Ethernet / PoE	

2. Preparations for IP Camera Setup

This chapter provides information about system requirements for IP Camera operation, power connection, Ethernet connection and ways to access to the camera.

2.1 System Requirements

To perform the IP Camera via web browser, please ensure your PC is in good network connection, and meet system requirements as described below.

Items	System Requirement
Personal Computer	1. Intel® Pentium® M, 2.16 GHz or Intel® Core™2 Duo, 2.0 GHz 2. 2 GB RAM or more
Operating System	Windows VISTA or Windows XP
Web Browser	Microsoft Internet Explorer 6.0 or later
Network Card	10Base-T (10 Mbps) or 100Base-TX (100 Mbps) operation
Viewer	ActiveX control plug-in for Microsoft IE

2.2 Installation

Please read the instructions provided in this chapter thoroughly before installing the Full HD Multi-Res Vandal Proof IP Dome Camera.

2.3 Power and Ethernet Cable Connection

Power Connection

Make sure the camera's power cable is correctly and firmly connected; refer to the pin definition table in section [2.2 Camera's Connectors](#). If using Power over Ethernet (PoE), make sure Power Sourcing Equipment (PSE) is in use in the network.

Ethernet Cable Connection

Use of Category 5 Ethernet cable is recommended for network connection; to have best transmission quality, cable length shall not exceed 100 meters. Connect one end of the Ethernet cable to the RJ-45 connector of the IP Dome Camera, and the other end of the cable to the network switch or PC.



NOTE: In some cases, you may need use an Ethernet crossover cable when connecting the IP Dome Camera directly to the PC.

Check the status of the link indicator and activity indicator LEDs; if the LEDs are unlit, please check LAN connection.

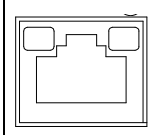

Green Link Light indicates good network connection.
Orange Activity Light flashes for network activity indication.

2.4 Hard Ceiling

The Vandal Proof IP Dome Camera can be installed directly on a wall or ceiling. Please note that the wall or ceiling must have enough strength to support the IP Dome Camera.

Follow the steps below to install the IP Dome Camera:

Step 1:

Unpack the Vandal Proof IP Dome Camera package and take out the IP Dome Camera.

Step 2:

Use the supplied Security Torx to unscrew the two Torx screws on the side of the Dome Cover, as shown in the figure, and open the Dome Cover.



Step 3:

Press both sides of the Inner Cover and remove it from the Dome Camera unit.

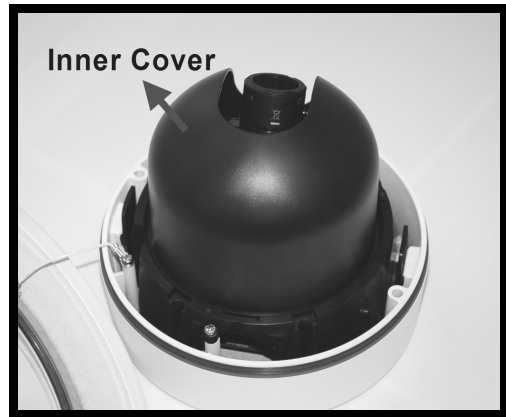

Step 4:

Unscrew the module-fastened screw, as indicated in the figure.

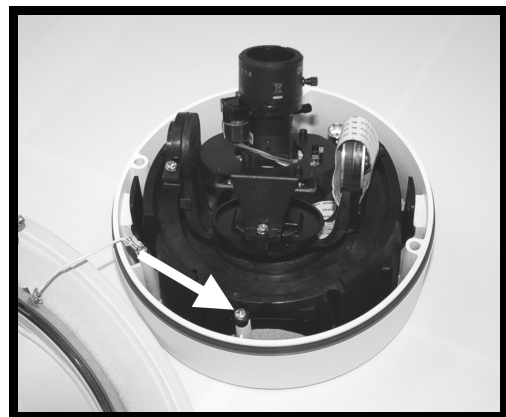

Step 5:

Press the sides of the snap-on module, as indicated in the figure, and detach it from the Dome Camera's housing.

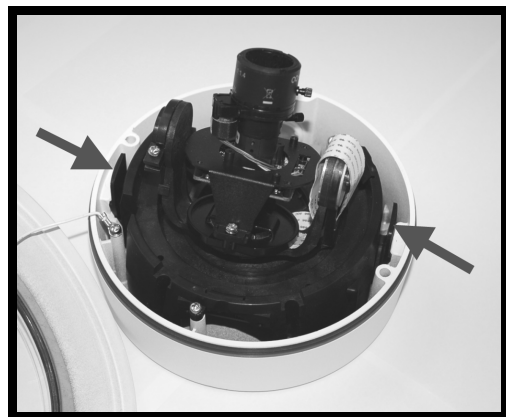

Step 6:

Mark the positions of the four screw holes on the base of the Dome Camera at the chosen installation location.

Step 7:

In the marked locations, drill each hole slightly smaller than the supplied screw anchors.

Step 8:

Put supplied anchors into these drilled holes.

Step 9:

Fasten the Dome Camera's housing with the four equipped self tapping screws.

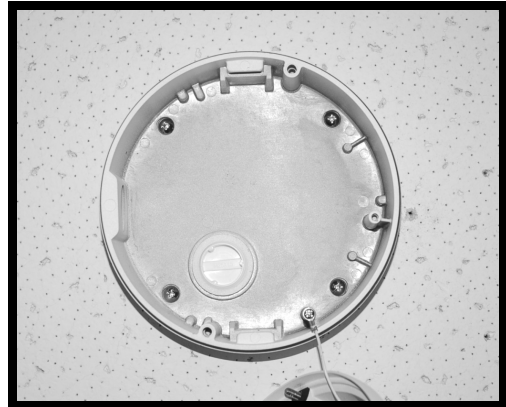

Step 10:

Thread the power and Ethernet cables through either the side conduit entry or back conduit entry, as illustrated. Users may use a coin to screw off the conduit entry block.

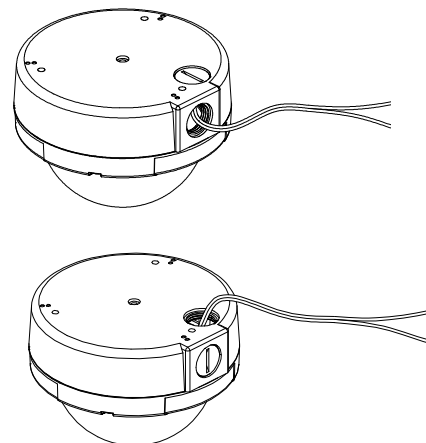

NOTE: The Power Cable is omitted if using PoE.

Step 11:

Connect the power and Ethernet cables to the mating connectors on the Dome Camera unit.

Step 12:

Attach the snap-on module into the Dome Camera housing, and screw the module-fastened screw tightly to secure the camera module.



NOTE: The terminal blocks should face the side conduit entry, as shown in the figure.

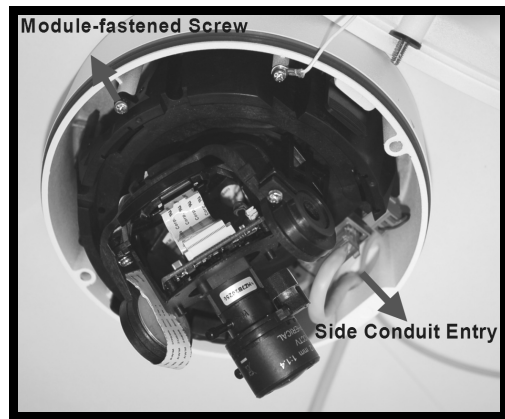

Step 13:

Connect the power and network outputs.



NOTE: The Power Cable is omitted if using PoE.

STEP 14:

Access the camera browser-viewer for viewing images. Please refer to [Accessing Camera](#) for further details. Users can also use the camera's BNC connector for video output.

Step 15:

Adjust the zoom ring screw to set the desired zoom; subsequently, modifying the focus ring screw to set the desired focal length.

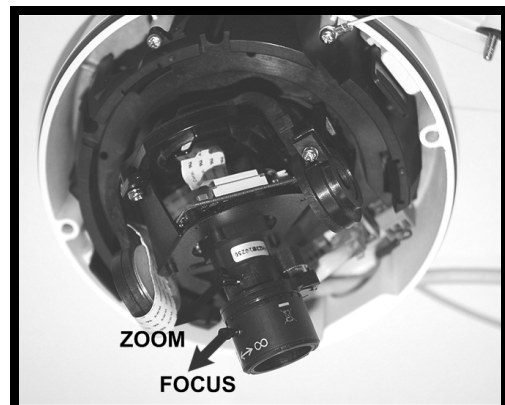

Step 16:

Adjust the camera to a desired angle, as shown below. Pan adjustment range is nearly 360°, rotation angle range approaches to 270°. Tilt is adjustable between - 10°~ 90°.

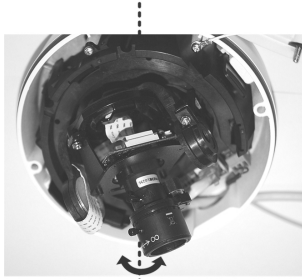

Pan Adjustment

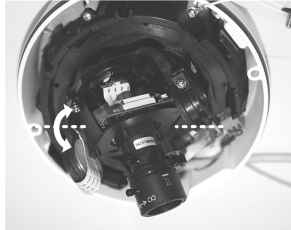

Rotation Adjustment

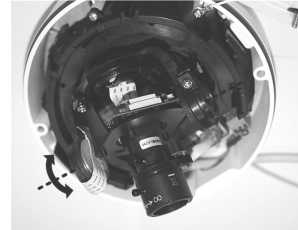

Tilt Adjustment



NOTE: Adjust the lens carefully within the limits mentioned above, or the cables underneath would be harmed.

STEP 17:

Put the Inner Cover back to the Dome Camera unit.



STEP 18:

Replace the Dome Cover back, aligning the arrow mark on the Dome Cover with the one on the housing as shown in the figure.



STEP 19:

Screw on the two Torx screws on the side of the Dome Cover tightly to fasten the Dome Cover. Camera installation is complete.



2.5 4S Mount Electrical Box

Before installing the IP Dome Camera in the 4S Electrical Box, please unscrew and open the Dome Cover with the Security Torx.

Figure: 4S Mount Electrical Box



STEP 1:

Run the wires (Ethernet and power) through the wall.



NOTE: The power cable is omitted if using PoE.

STEP 2:

Disassemble the Dome Camera's Inner Cover (see the illustration in [5.2 Hard Ceiling: Step 3](#)) from the Dome Camera unit.

STEP 3:

Detach the snap-on camera module from the Dome Camera's housing by unscrewing the module-fastened screw first. Then press the sides of camera module and pull it slightly up from the housing.

STEP 4:

Thread the power and Ethernet cables through either the side conduit entry or back conduit entry. Then fasten the Dome Camera's housing on the Electrical Box with the two screws.

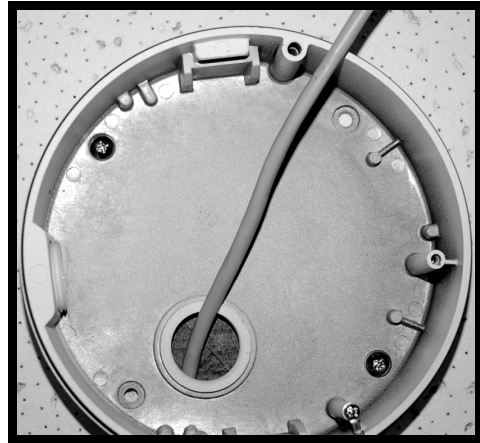

STEP 5:

Connect the power and Ethernet cables to their connectors on the Dome Camera unit.

STEP 6:

Attach the snap-on camera module onto the Dome Camera's housing and screw the module-fastened screw tightly to secure the camera module.

STEP 7:

Access the camera browser-viewer for viewing images. Please refer to [6. Accessing Camera](#) for further details. Users can also use the camera's BNC connector for video output.

Step 8:

Adjust the camera's zoom level and focal length via zoom and focus ring screws.

STEP 9:

Position the camera at a desired angle by Pan/Tilt/Rotation adjustment.

STEP 10:

Replace the Dome Cover back, aligning the arrow mark on the Dome Cover with the one on the housing.

STEP 11:

Screw on the two Torx screws on the side of the Dome Cover tightly to fasten the Dome Cover. Camera installation is complete.

3. Accessing Camera

For initial access to the IP Camera, users can search the camera through the installer program: DeviceSearch.exe, which can be found in “Device Search” folder in the supplied CD.

Device Search Software Setup

Step 1: Double click on the program Device Search.exe (see the icon below); its window will appear as shown below. Then click the “Device Search” button.

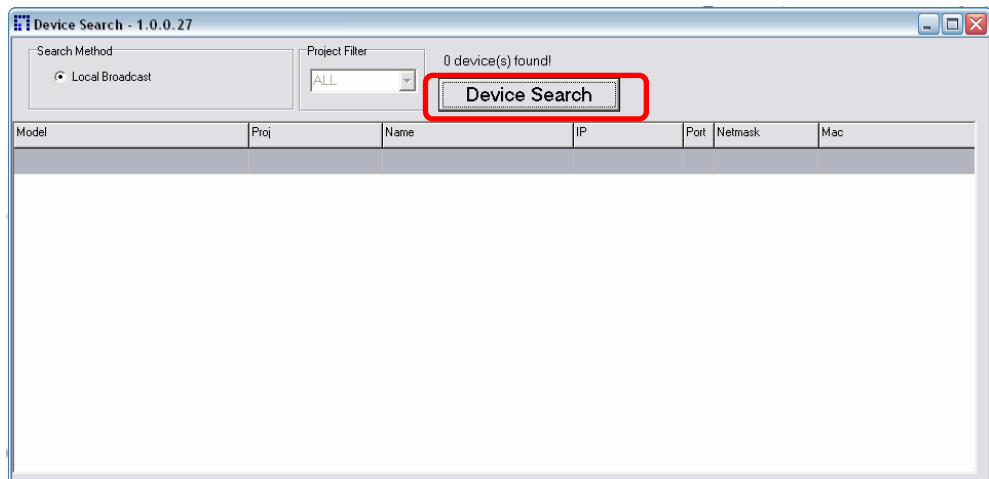

Step 2: The security alert window will pop up. Click “Unblock” to continue.



Device Search

Step 3: Click “Device Search” again, and all the finding IP devices will be listed in the page, as shown in the figure below. The IP Camera’s default IP address is: **192.168.0.250**.

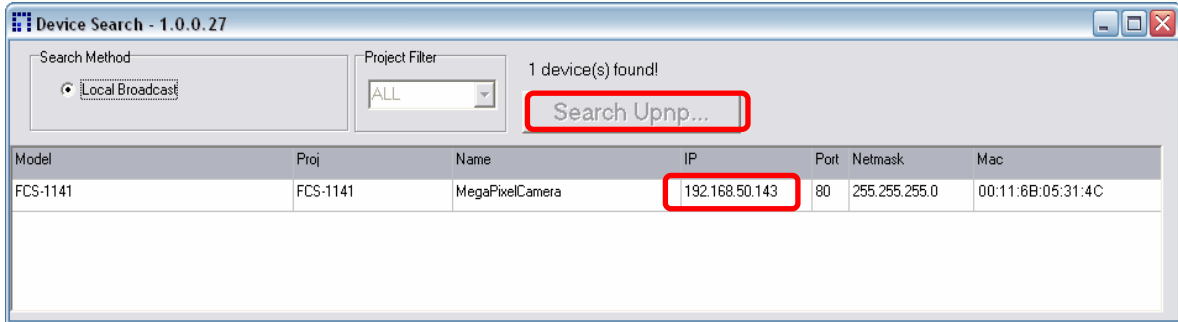

Step 4: Double click or right click and select “Browse” to access the camera directly via web browser.

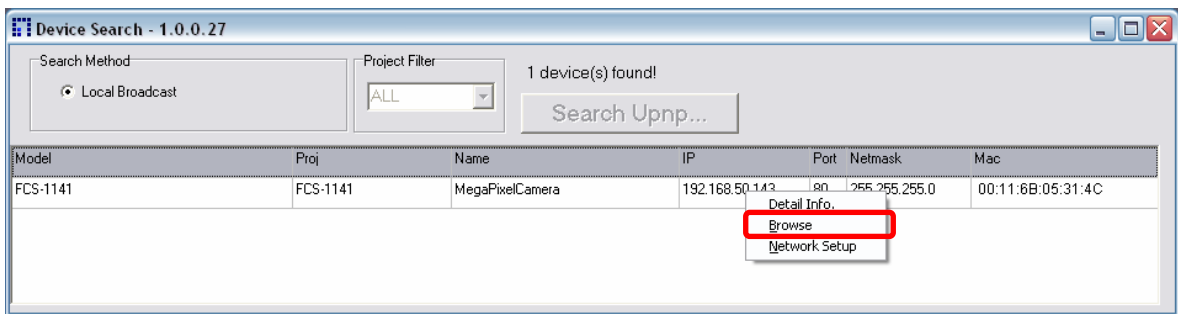

Step 5: Then the prompt window of request for entering default username and password (as shown below) will appear for logging in to the IP Camera.



The default login ID and password are:

Login ID	Password
root	



NOTE: ID and password are case sensitive.



NOTE: It is strongly advised that administrator's password be altered for the security concerns. Refer to section [5.3.2 Security](#) for further details.

Additionally, users can change the IP Camera's network property, either DHCP or Static IP, directly in the device finding list. Refer to the following section for changing the IP Camera's network property.

Example of Changing IP Camera's Network Property

Users can directly change an IP Camera's network property, ex. from static IP to DHCP, in the finding device list. The way to change the IP Camera's network property is specified below:

Step 1: In the finding device list, click on the IP Camera that you would like to change its network property. On the selected item, right click and select "Network Setup." Meanwhile, record the IP Camera's MAC address, for future identification.

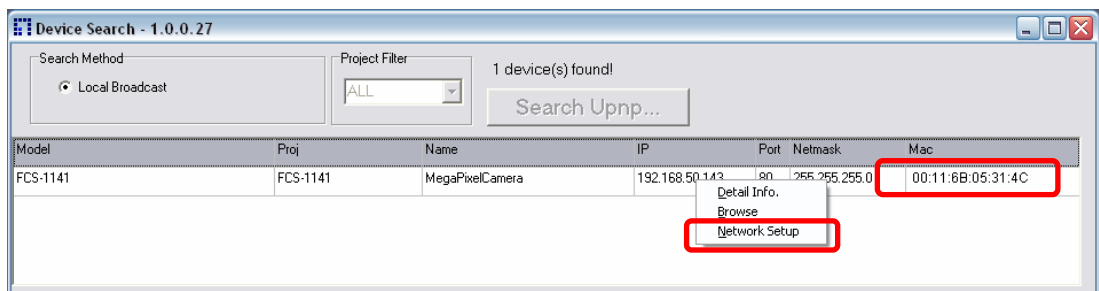

Step 2: The "Network Setup" page will come out. Select "DHCP," and press "Apply" button down the page.

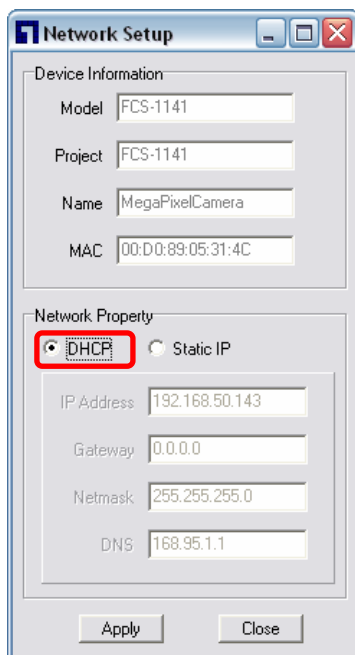

Step 3: Click “OK” on the Note of setting change. Wait for one minute to re-search the IP Camera.



Step 4: Click the “Device Search” button to search all the devices. Then select the IP Camera with the correct MAC address. Double click on the IP Camera, and the login window will come out.

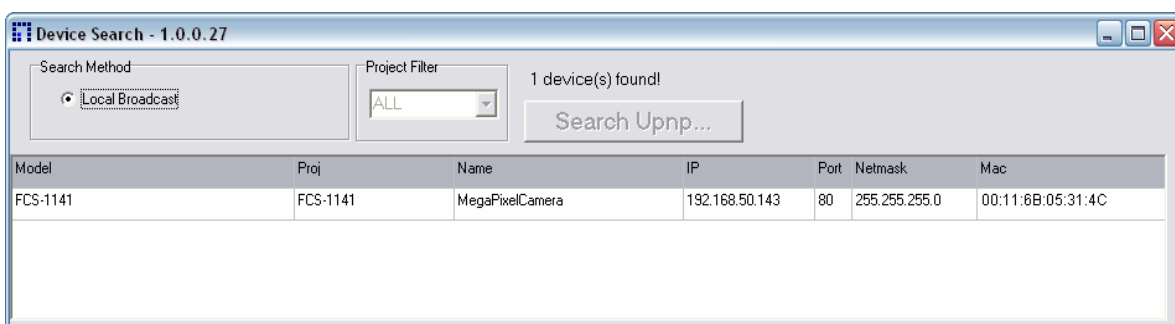

Step 5: Enter User name and Password to access the IP Camera.

Using recording software

The product software CD also contains recording software-IP CamSecure, allowing simultaneous monitoring and video recording for multiple Network Cameras. Please install the recording software; then launch the program to add the Network Camera to the Channel list. For detailed information about how to use IP CamSecure, please refer to the user's manual of the software or download it at <http://global.level1.com>.



Installing DC Viewer Software Online

For the initial access to the IP Camera, a client program, DC Viewer, will be automatically installed to your PC when connecting to the IP Camera.

If the Web browser doesn't allow DC Viewer installation, please check the Internet security settings or ActiveX controls and plug-ins settings (see [Appendix B: Internet Security Settings](#)) to continue the process.

The Information Bar (just below the URL bar) may come out and ask for permission to install the ActiveX Control for displaying video in browser (see the figure below). Right click on the Information Bar and select "Install ActiveX Control..." to allow the installation.

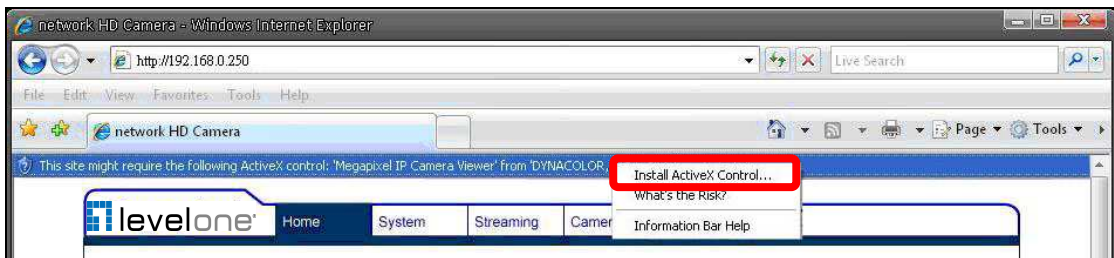

Then the security warning window will pop up. Click "Install" to carry on software installation.



Click "Finish" to close the DC Viewer window when download is finished. For the detailed software download procedure, please refer to [Appendix C: DC Viewer Download Procedure](#).

Once login to the IP Camera, users will see the Home page as shown below:

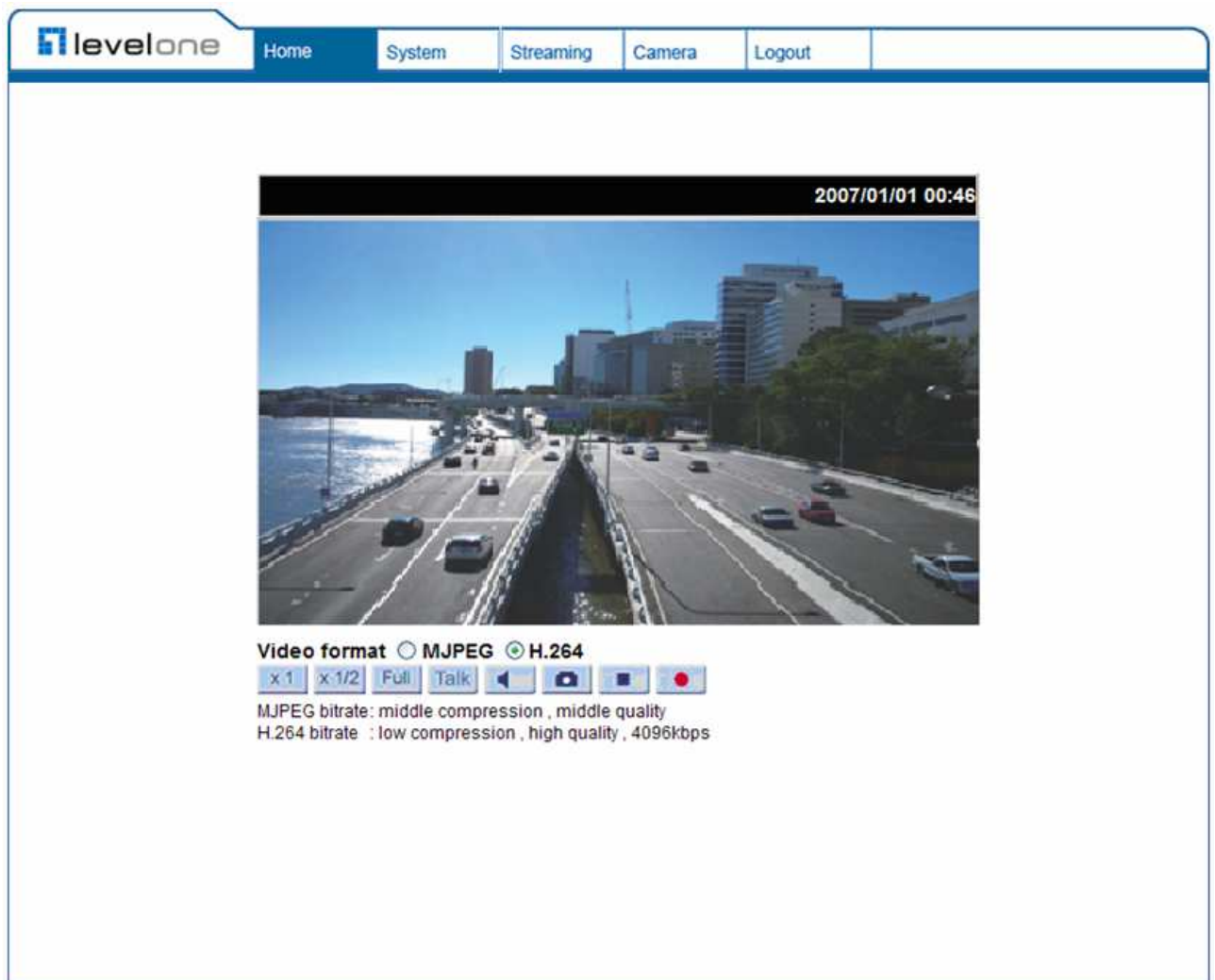

NOTE: The “talk” button below the screen only displays in Box Camera and Vandal Proof IP Dome.

Administrator/User Privileges

“Administrator” represents the person who can configure the IP Camera and authorize users access to the camera; “User” refers to whoever has access to the camera with limited authority, i.e. entering Home and Camera setting pages.

Image and Focus Adjustment

The image displays on the Home page when successfully accessing to the IP Camera. Adjust zoom and focus as necessary to produce a clear image.

4. Configuration & Operation

The IP Camera is provided with a user-friendly browser-based configuration interface, and a free bundled IP CamSecure Lite for record and playback video. In this chapter, information about main page introduction, system related settings and camera settings will be described in detail.

For further information about IP CamSecure, please refer to IP CamSecure user manual.

4.1 Browser-based Viewer Introduction

The figure below shows the Home page of the IP Camera's viewer window.

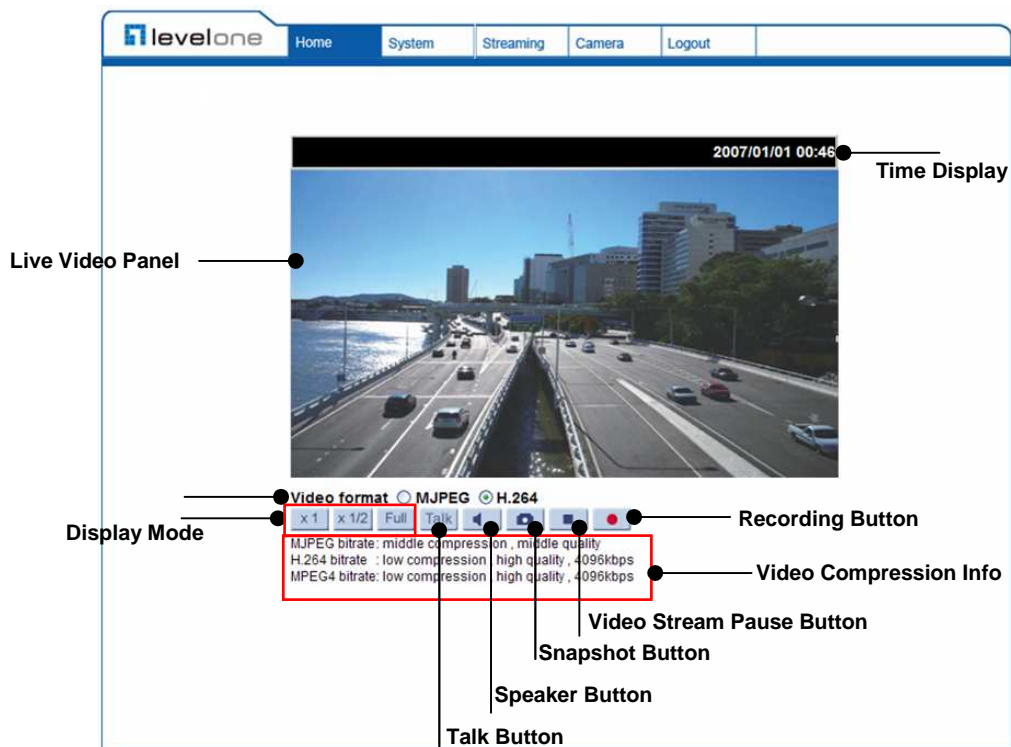

NOTE: Only the Box Camera and Vandal Proof IP Dome support the "Talk" function.

There are five tabs: Home, System, Streaming, Camera and Logout on the top panel.

Home

Users can monitor live video of the targeted area.

System setting

The administrator can set host name, system time, root password, network related settings, etc. Further details will be interpreted in section [4.3 System Related Settings](#).

Streaming setting

The administrator can modify video resolution and rotate type and select audio compression mode in this page.

Camera setting

Users can adjust various camera parameters, including <Exposure>, <White Balance>, <Brightness>, <Sharpness>, <Contrast> and <Digital Zoom>.

Logout

Click on the tab to re-login the IP Camera with another username and password.

4.2 Home Page

In the Home page, there are several function buttons right down the displayed image.



NOTE: Please note that the function buttons will vary depending on the camera model.

Screen Size Adjustment

Image display size can be adjusted to x1/2 and full screen.

Digital Zoom Control

In the full screen mode, users can implement digital PTZ by rotating the mouse wheel (for zoom in/out), and drag the mouse into any direction.

Talk button (on/off)

Talk function allows the local site to talk to the remote site. Click on the button to switch it to on/off. Please refer to section [4.3.2 Security: Add user >> Talk/Listen](#) for further details. This function is only open to “User” who has been granted this privilege by the Administrator.



NOTE: This function is only available for the Box Camera and Vandal Proof IP Dome.

Speaker button (on/off)

Press the Speaker button to mute/activate the audio.

Snapshot button

Press the button, and the JPEG snapshots will automatically be saved in the appointed place. The default place of saving snapshots is: C:\. To change the storage location, please refer to section [5.3.11 File Location](#) for further details.

Video Streaming Pause /Restart button (pause/restart)

Press the stop button to disable video streaming, the live video will be displayed as black. Press the restart button to show the live video again.

Recording button (on/off)

Press the button and the recordings from the Live View will be saved to the location specified in the “File Location” (snapshot) page; see section [4.3.11 File Location](#) for further details.

4.3 System Related Settings

The figure below shows all categories under the “**System**” tab. Each category in the left column will be explained in the following sections.



NOTE: The “System” configuration page is only accessible by the Administrator.

levelone Home System Streaming Camera Logout

System

Host Name : MegaPixelCamera

Time zone : GMT+00:00 Gambia, Liberia, Morocco, England

Enable daylight saving time

time offset: 01:00:00

Start date: Jan 1st Sun Start time: 00:00:00

End date: Jan 1st Sun End time: 00:00:00

Sync with computer time

PC date: 2010/07/06 [yyyy/mm/dd]

PC time: 16:24:00 [hh:mm:ss]

Manual

Date: 2007/01/01 [yyyy/mm/dd]

Time: 00:00:00 [hh:mm:ss]

Sync with NTP server

NTP server: 0.0.0.0 [host name or IP address]

Update interval: Every hour

Save

4.3.1 Host Name and System Time Setting

Press the first category: <System> in the left column; the page is shown as below.

The screenshot shows the LevelOne web interface. The top navigation bar includes 'Home', 'System', 'Streaming', 'Camera', and 'Logout'. On the left, a vertical menu lists various system categories, with 'System' highlighted by a red rectangle. The main content area is titled 'System' and contains the following configuration options:

- Host Name :** MegaPixelCamera
- Time zone :** GMT+00:00 Gambia, Liberia, Morocco, England
- Enable daylight saving time**
 - time offset: 01:00:00
 - Start date: Jan 1st Sun Start time: 00:00:00
 - End date: Jan 1st Sun End time: 00:00:00
- Sync with computer time**
 - PC date: 2010/07/06 [yyyy/mm/dd]
 - PC time: 16:24:00 [hh:mm:ss]
- Manual**
 - Date: 2007/01/01 [yyyy/mm/dd]
 - Time: 00:00:00 [hh:mm:ss]
- Sync with NTP server**
 - NTP server: 0.0.0.0 [host name or IP address]
 - Update interval: Every hour

A 'Save' button is located at the bottom of the configuration area.

Host Name

The name is for camera identification. If alarm function (see section [4.3.7 Application](#)) is enabled and is set to send alarm message by Mail/FTP, the host name entered here will display in the alarm message.

Time Zone

Select the time zone you are in from the drop-down menu.

Sync With Computer Time

To enable DST, please check the item and then specify time offset and DST duration. The format for time offset is [hh:mm:ss]; for instance, if the amount of time offset is one hour, please enter "01:00:00" into the field.

Sync With Computer Time

Select the item, and video date and time display will synchronize with the PC's.

Manual

The Administrator can set video date, time and day manually. Entry format should be identical with that shown next to the enter fields.

Sync with NTP server

Network Time Protocol (NTP) is an alternate way to synchronize your camera's clock with a NTP server. Please specify the server you wish to synchronize in the enter field. Then select an update interval from the drop-down menu. For further information about NTP, please see the web site: www.ntp.org.

4.3.2 Security

Click the category: <Security>, and the page is shown as the figure below.

The screenshot shows the LevelOne web interface. The top navigation bar includes 'Home', 'System', 'Streaming', 'Camera', and 'Logout'. The left sidebar contains a list of system categories: System, Security (highlighted with a red box), Network, DDNS, Mail, FTP, Application, Motion detection, Storage management, Recording, File location, Iris adjustment, View log file, View user information, View parameters, Factory default, Software version, Software upgrade, and Maintenance. The main content area is titled 'Security' and contains three sections: 'Root Password' with two password input fields and a 'Save' button; 'Add User' with fields for 'User name' and 'User password', and checkboxes for 'I/O access', 'Camera control', 'Talk', and 'Listen', with an 'Add' button; and 'Manage User' with a 'User name' dropdown menu and 'Delete' and 'Edit' buttons.

Root password

Change the administrator's password by inputting the new password in both text boxes. The input characters/numbers will be displayed as dots for security purposes. After clicking <Save>, the web browser will ask the Administrator for the new password for access. The maximum length of the password is 14 digits.



NOTE: The following characters are valid: A-Z, a-z, 0-9, !#\$%&'-.@^_~.

Add user

Type the new user's name and password and click <Add> to add the new user. Both user name and password can be up to 16 characters. The new user will be displayed in the user name list. There is a maximum of twenty user accounts. Each user can be assigned the privileges of “**Camera control**”, “**Talk**” and “**Listen**”.

- **I/O access**
This item supports fundamental functions that enable users to view video when accessing to the camera.
- **Camera control**
This item allows the appointed User to change camera parameters on the Camera Setting page.
- **Talk/Listen**
Talk and Listen functions allow the appointed user in the local site (PC site) communicating with, for instance, the administrator in the remote site.



NOTE: The Compact IP Dome does not have Talk function.

Manage User

Delete user

To delete a user, pull down the user list, and select the user name you wish to delete. Then click <Delete> to remove it.

Edit user

Pull down the user list and select a user name. Click <Edit> to edit the user's password and privilege.



NOTE: It is required to enter the User password as well as select the function open to the user. When finished, click <Save> to modify the account authority.



4.3.3 Network

Click <Network> in the left column, and the page will display as shown below.

The screenshot shows the 'levelone' web interface. The left sidebar contains a menu with items: System, Security, Network (highlighted with a red box), DDNS, Mail, FTP, Application, Motion detection, Storage management, Recording, File location, Iris adjustment, View log file, View user information, View parameters, Factory default, Software version, Software upgrade, and Maintenance. The main content area is titled 'Network' and has a 'General' section. Under 'General', there are two radio button options: 'Get IP address automatically' (selected) and 'Use fixed IP address'. Below these are input fields for IP address (192.168.0.99), Subnet mask (255.255.255.0), Default gateway (192.168.0.254), Primary DNS (0.0.0.0), and Secondary DNS (0.0.0.0). There is also a section for 'Use PPPoE' with input fields for User name and Password, and a 'Save' button. An 'Advanced' section includes input fields for Web Server port (80), RTSP port (554), and MJPEG over HTTP port (8008), with a 'Save' button. A 'UPnP Setting' section includes a checked checkbox for 'Enable UPnP', an unchecked checkbox for 'Enable UPnP port forwarding', and a 'Friendly name' input field (FCS-1141) with a 'Save' button.

Users can choose to connect to the IP Camera with fixed or dynamic (DHCP) IP address. The IP Camera also provides PPPoE support for users who connect to the network via PPP over Ethernet (PPPoE).

Get IP address automatically (DHCP)

The camera's default setting is "Use fixed IP address". Please refer to the previous section [4. Accessing Camera](#) for login with the default IP address.

If select "Get IP address automatically", after the IP Camera restarts, users can search it through the installer program: DeviceSearch.exe, which can be found in "DeviceSearch" folder in the supplied CD.



NOTE: Please make the record of the IP Camera's MAC address, which can be found in the label of the camera, for identification in the future.

Use fixed IP address

To setup static IP address, select “**Use fixed IP address**” and move the cursor to the IP address blank (as indicated below) and insert the new IP address, ex. 192.168.7.123; then go to the Default gateway (explained latter) blank and change the setting, ex. 192.168.7.254. Press “Save” to confirm the new setting.

The screenshot shows the 'levelone' web interface. The left sidebar contains a menu with items like System, Security, Network, DDNS, Mail, FTP, Application, Motion detection, Storage management, Recording, File location, Iris adjustment, View log file, View user information, View parameters, Factory default, Software version, Software upgrade, and Maintenance. The main content area is titled 'Network' and has a 'General' section. Under 'General', there are two radio buttons: 'Get IP address automatically' (unselected) and 'Use fixed IP address' (selected). Below these are input fields for 'IP address' (192.168.7.123), 'Subnet mask' (255.255.255.0), 'Default gateway' (192.168.7.254), 'Primary DNS' (0.0.0.0), and 'Secondary DNS' (0.0.0.0). There is also a section for 'Use PPPoE' with fields for 'User name' and 'Password', and a 'Save' button. Below that is an 'Advanced' section with 'Web Server port' (80), 'RTSP port' (554), and 'MJPEG over HTTP port' (8008), each with a 'Save' button. At the bottom is a 'UPnP Setting' section with 'Enable UPnP' checked, 'Enable UPnP port forwarding' unchecked, and a 'Friendly name' field containing 'FCS-1131' with a 'Save' button.

When using static IP address to login to the IP Camera, users can access it either through “DeviceSearch” software (see [4. Accessing Camera](#)) or input the IP address in the URL bar and press “Enter”.

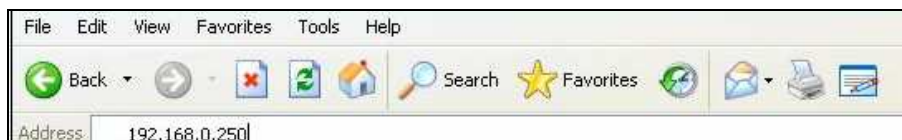

- **IP address**
This is necessary for network identification.
- **Subnet mask**
It is used to determine if the destination is in the same subnet. The default value is “255.255.255.0”.

- **Default gateway**
This is the gateway used to forward frames to destinations in different subnet. Invalid gateway setting will fail the transmission to destinations in different subnet.
- **Primary DNS**
Primary DNS is the primary domain name server that translates hostnames into IP addresses.
- **Secondary DNS**
Secondary DNS is a secondary domain name server that backups the primary DNS.

Use PPPoE

For the PPPoE users, enter the PPPoE Username and Password into the fields, and click on the “Save” button to complete the setting.

Advanced

- **Web Server port**
The default web server port is 80. Once the port is changed, the user must be notified the change for the connection to be successful. For instance, when the Administrator changes the HTTP port of the IP Camera whose IP address is 192.168.0.100 from 80 to 8080, the user must type in the web browser “http://192.168.0.100:8080” instead of <http://192.168.0.100>
- **RTSP port**
RTSP port could be set from 1 to 65535. (Normal Setting Port: 554, 1024 ~65535)
- **MJPEG over HTTP port**
The default setting of HTTP Port is 8008; setting range: 1024 ~65535.



NOTE: Be aware to choose the different port from the one set for the web server port.

UPnP Setting

- **Enable UPnP**

When the UPnP is enable, whenever the IP Camera is presented to the LAN, the icon of the connected IP Cameras will appear in My Network Places to allow for direct access as shown below.

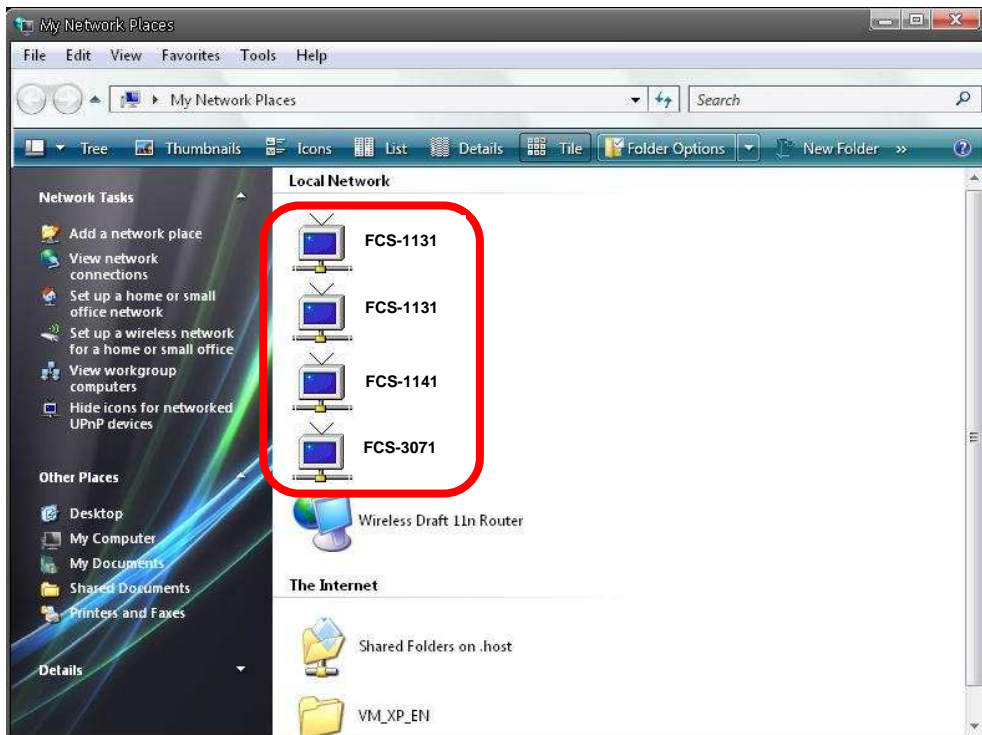
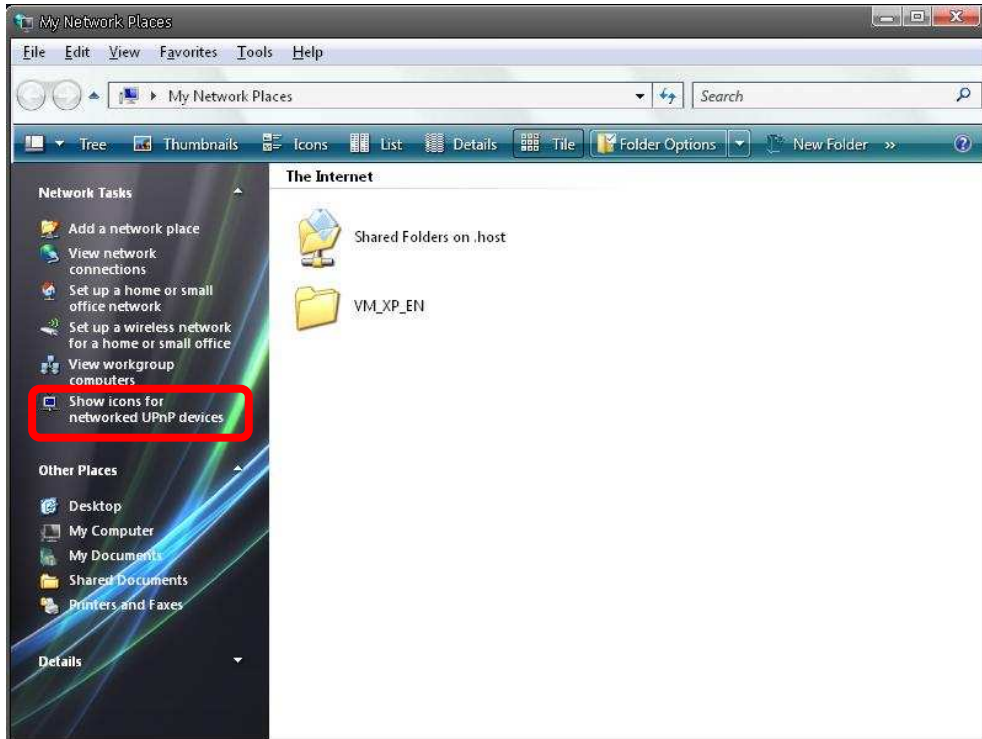



NOTE: To enable this function, please make sure the UPnP component is installed on your computer. Please refer to [Appendix D: Install UPnP components](#) for UPnP component installation procedure.

- **Enable UPnP port forwarding**

When the UPnP port forwarding is enabled, the IP Camera is allowed to open the web server port on the router automatically.



NOTE: To enable this function, please make sure that your router supports UPnP and it is activated

- **Friendly name**

Set the name for the IP Camera for identity.

4.3.4 DDNS

Dynamic Domain Name System (DDNS) allows a host name to be constantly synchronized with a dynamic IP address. In other words, it allows those using a dynamic IP address to be associated to a static domain name so others can connect to it by name.

The screenshot displays the 'levelone' web interface. The top navigation bar includes 'Home', 'System', 'Streaming', 'Camera', and 'Logout'. The left sidebar contains a list of menu items: System, Security, Network, **DDNS** (highlighted with a red box), Mail, FTP, Application, Motion detection, Storage management, Recording, File location, Iris adjustment, View log file, View user information, View parameters, Factory default, Software version, Software upgrade, and Maintenance. The main content area is titled 'DDNS' and contains the following configuration options:

- Dynamic DNS**
Use Dynamic DNS If You Want To Use Your DDNS Account.
- Enable DDNS
- Provider: DynDNS.org(Dynamic) (dropdown menu)
- Host name: [text input field]
- Username/E-mail: [text input field]
- Password/Key: [text input field]
- Save (button)

Enable DDNS

Check the item to enable DDNS.

Provider

Select one DDNS host from the provider list.

Host name

Enter the registered domain name in the field.

Username/E-mail

Enter the username or e-mail required by the DDNS provider for authentication.

Password/Key

Enter the password or key required by the DDNS provider for authentication.

4.3.5 Mail

The Administrator can send an e-mail via Simple Mail Transfer Protocol (SMTP) when motion is detected. SMTP is a protocol for sending e-mail messages between servers. SMTP is a relatively simple, text-based protocol, where one or more recipients of a message are specified and the message text is transferred. The configuration page is shown as follows:

The screenshot displays the LevelOne web interface. The top navigation bar includes 'Home', 'System', 'Streaming', 'Camera', and 'Logout'. The left sidebar contains a list of system management options: System, Security, Network, DDNS, Mail (highlighted with a red box), FTP, Application, Motion detection, Storage management, Recording, File location, Iris adjustment, View log file, View user information, View parameters, Factory default, Software version, Software upgrade, and Maintenance. The main content area is titled 'Mail' and contains an 'SMTP' configuration section. This section includes two sets of input fields for SMTP server configuration. The first set includes fields for '1st SMTP (mail) server', '1st SMTP (mail) server port' (with '25' entered), '1st SMTP account name', and '1st SMTP password'. The second set includes fields for '2nd SMTP (mail) server', '2nd SMTP (mail) server port' (with '25' entered), '2nd SMTP account name', and '2nd SMTP password'. Below these are fields for '1st recipient email address', '2nd recipient email address', and 'Sender email address'. A 'Save' button is located at the bottom right of the configuration area.

Two sets of SMTP can be configured. Each set includes SMTP Server, Account Name, Password and E-mail Address settings. For SMTP server, contact your network service provider for more specific information.

4.3.6 FTP

The Administrator can set as sending alarm message to a specific File Transfer Protocol (FTP) site when motion is detected. Users can assign alarm message to up to two FTP sites. The FTP setting page is shown below. Enter the FTP details, which include server, server port, user name, password and remote folder, in the fields. Press “Save” when finished.

The screenshot shows the 'levelone' web interface. The top navigation bar includes 'Home', 'System', 'Streaming', 'Camera', and 'Logout'. The left sidebar menu has the following items: System, Security, Network, DDNS, Mail, **FTP** (highlighted with a red box), Application, Motion detection, Storage management, Recording, File location, Iris adjustment, View log file, View user information, View parameters, Factory default, Software version, Software upgrade, and Maintenance. The main content area is titled 'FTP' and contains the following configuration options:

- Built-in FTP server port:
- 1st FTP server:
- 1st FTP server port:
- 1st FTP user name:
- 1st FTP password:
- 1st FTP remote folder:
- 1st FTP passive mode
- 2nd FTP server:
- 2nd FTP server port:
- 2nd FTP user name:
- 2nd FTP password:
- 2nd FTP remote folder:
- 2nd FTP passive mode

A 'Save' button is located at the bottom of the configuration area.

4.3.7 Application (Excluding Compact IP Dome)

The IP Camera (Box Camera and Vandal Proof Dome) equips one alarm input and one relay output for cooperating with alarm system to catch events' images. Refer to alarm pin definition below to connect alarm devices to the IP Camera if needed. The alarm configuration page is also shown below.

Alarm Pin Definition

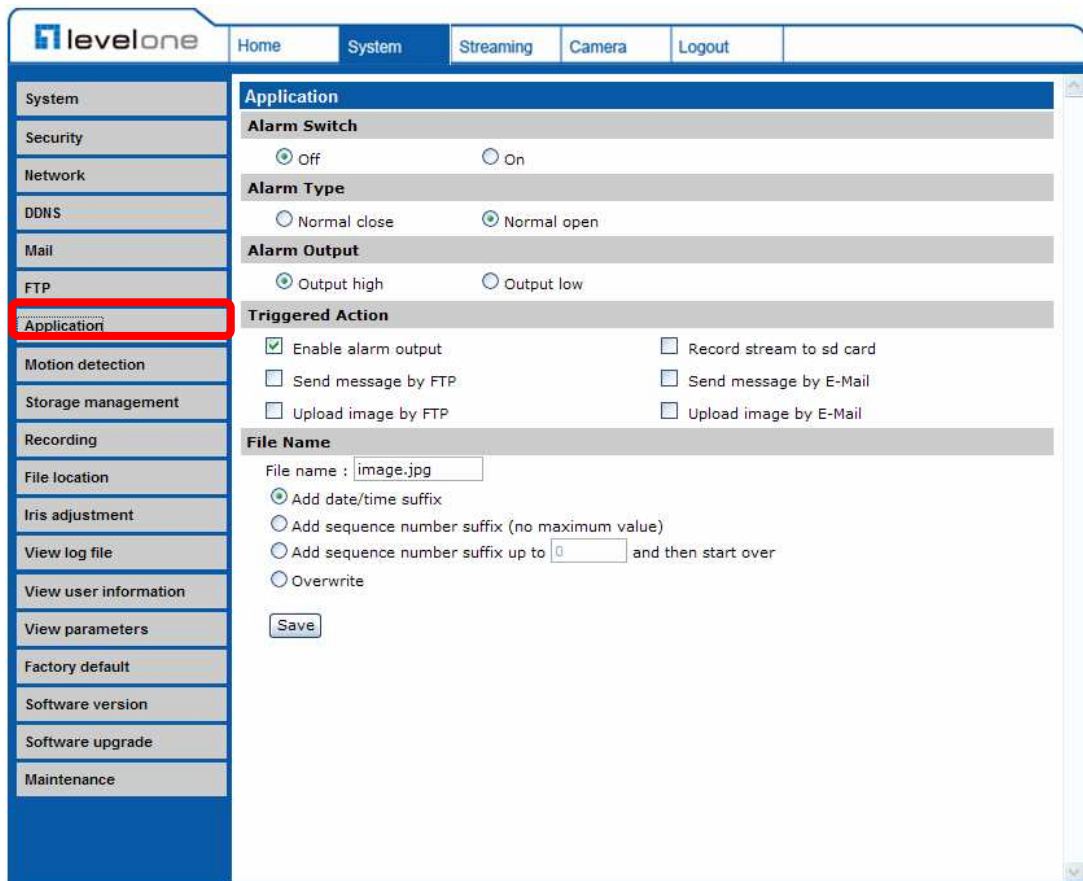
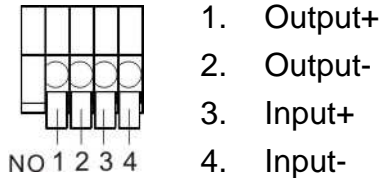

Alarm Switch

The Administrator can enable or disable the alarm function.

Alarm Type

Select an alarm type, “Normal close” or “Normal open,” that corresponds with the alarm application.

Alarm Output

Define alarm output signal “high” or “low” as the normal alarm output status according to the current alarm application.

Triggered Action (Multi-option)

The Administrator can specify alarm actions that will take when the alarm is triggered. All options are listed as follows:

- **Enable Alarm Output**

Select the item to enable alarm relay output.

- **Send Alarm Message by FTP/E-Mail**

The Administrator can select whether to send an alarm message by FTP and/or E-Mail when an alarm is triggered.

- **Upload Image by FTP**

Select this item, and the Administrator can assign a FTP site and configure various parameters as shown in the figure below. When the alarm is triggered, event images will be uploaded to the appointed FTP site.

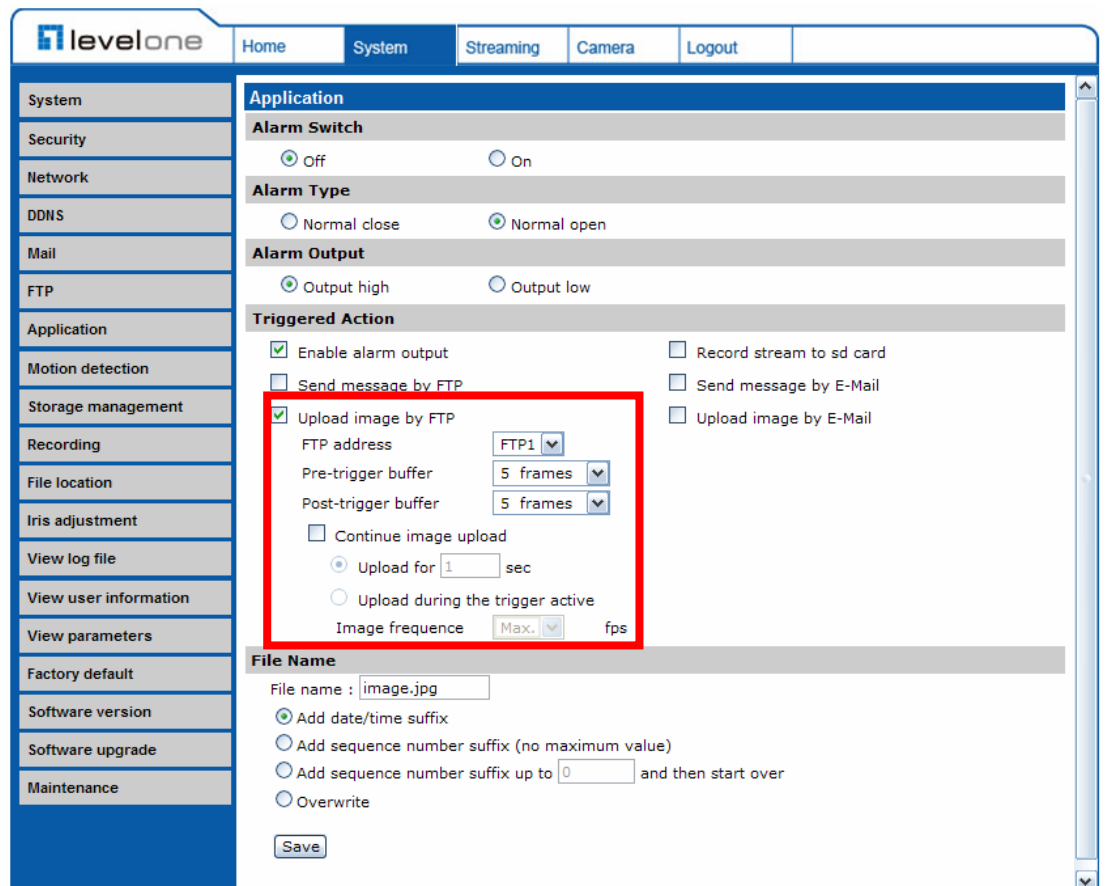

The screenshot displays the LevelOne web interface for configuring alarm settings. The left sidebar contains a navigation menu with options like System, Security, Network, DDNS, Mail, FTP, Application, Motion detection, Storage management, Recording, File location, Iris adjustment, View log file, View user information, View parameters, Factory default, Software version, Software upgrade, and Maintenance. The main content area is titled 'Application' and includes sections for 'Alarm Switch', 'Alarm Type', 'Alarm Output', 'Triggered Action', and 'File Name'. The 'Triggered Action' section is highlighted with a red box, showing the following configuration: 'Enable alarm output' is checked, 'Send message by FTP' is unchecked, 'Upload image by FTP' is checked, 'FTP address' is set to 'FTP1', 'Pre-trigger buffer' is '5 frames', 'Post-trigger buffer' is '5 frames', 'Continue image upload' is unchecked, 'Upload for' is set to '1' sec, 'Upload during the trigger active' is selected, and 'Image frequency' is 'Max.' fps. The 'File Name' section shows 'File name : image.jpg' and options for adding date/time suffix, sequence number suffix, or overwriting.

- **Record Stream to SD Card**

Select the item, and the alarm-triggered recording will be saved into your Micro SD card.

The screenshot shows the LevelOne web interface with the 'Application' configuration page. The 'Record stream to sd card' option is checked and highlighted with a red box. The configuration includes the following sections:

- Alarm Switch:** Off, On
- Alarm Type:** Normal close, Normal open
- Alarm Output:** Output high, Output low
- Triggered Action:**
 - Enable alarm output
 - Record stream to sd card
 - Pre-trigger buffer: 1 sec
 - Upload for 1 sec
 - Upload during the trigger active
 - Send message by FTP
 - Send message by E-Mail
 - Upload image by FTP
 - Upload image by E-Mail
- File Name:**
 - File name: image.jpg
 - Add date/time suffix
 - Add sequence number suffix (no maximum value)
 - Add sequence number suffix up to 0 and then start over
 - Overwrite

A 'Save' button is located at the bottom of the configuration area.



NOTE: Please make sure the local recording (with Micro SD/SDHC card) is activated so that this function can be implemented. See section [4.3.10 Recording](#) for further details.

- **Upload Image by E-Mail**

Select this item, and the Administrator can assign an e-mail address and configure various parameters as shown in the figure below. When the alarm is triggered, event images will be sent to the appointed e-mail address.

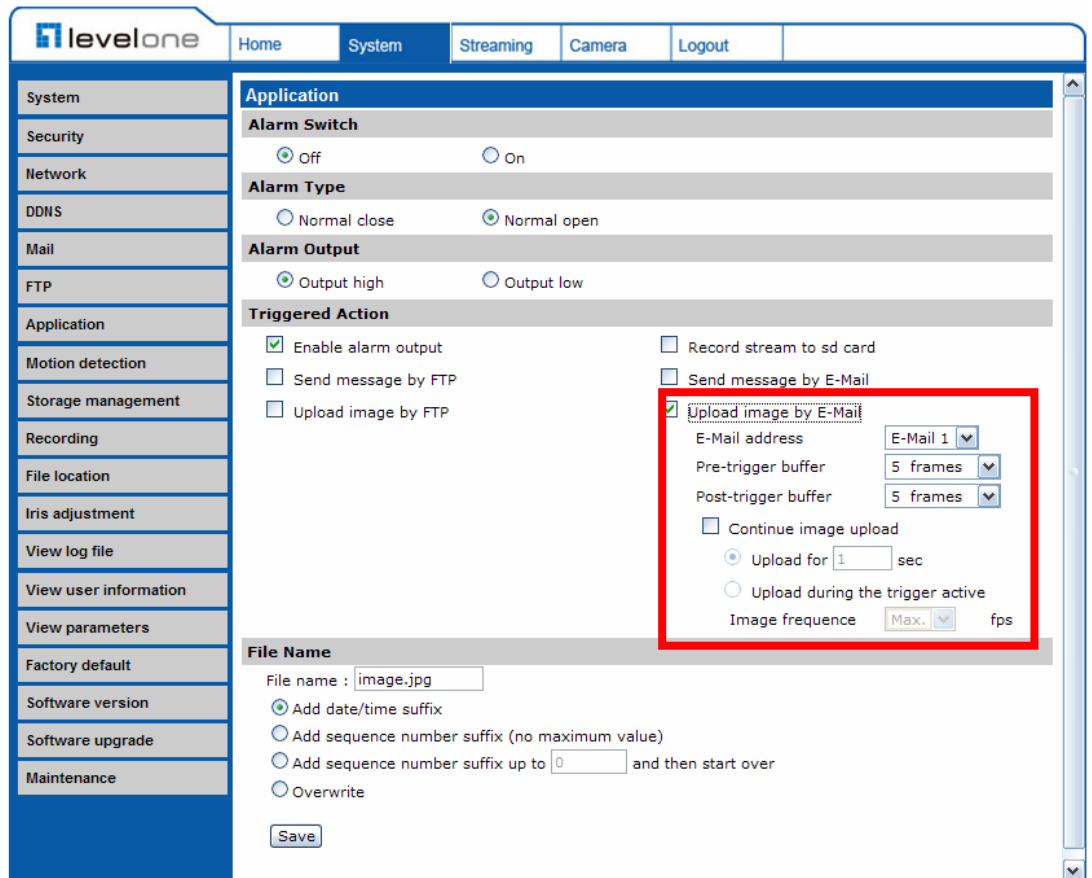

NOTE: Make sure SMTP or FTP configuration has been completed. See section [4.3.5 Mail](#) and [4.3.6 FTP](#) for further details.

File Name

Enter a file name in the blank, ex. image.jpg. The uploaded image's file name format can be set in this section. Please select the one that meets your requirements.

- **Add date/time suffix**

File name: imageYYMMDD_HHNNSS_XX.jpg

Y: Year, M: Month, D: Day

H: Hour, N: Minute, S: Second

X: Sequence Number

- **Add sequence number suffix (no maximum value)**

File name: imageXXXXXXXX.jpg

X: Sequence Number

- **Add sequence number suffix (limited value)**

File Name: imageXX.jpg

X: Sequence Number

The file name suffix will end at the number being set. For example, if the setting is up to "10," the file name will start from 00, end at 10, and then start all over again.

- **Overwrite**

The original image in the FTP site will be overwritten by the new uploaded file with a static filename.

Save

After complete all the settings mentions above, please click on the Save button to save all the settings in this page.

4.3.8 Motion Detection

Motion Detection function allows detecting suspicious motion and triggering alarms when motion volume in the detected area reaches/exceeds the determined sensitivity threshold value.

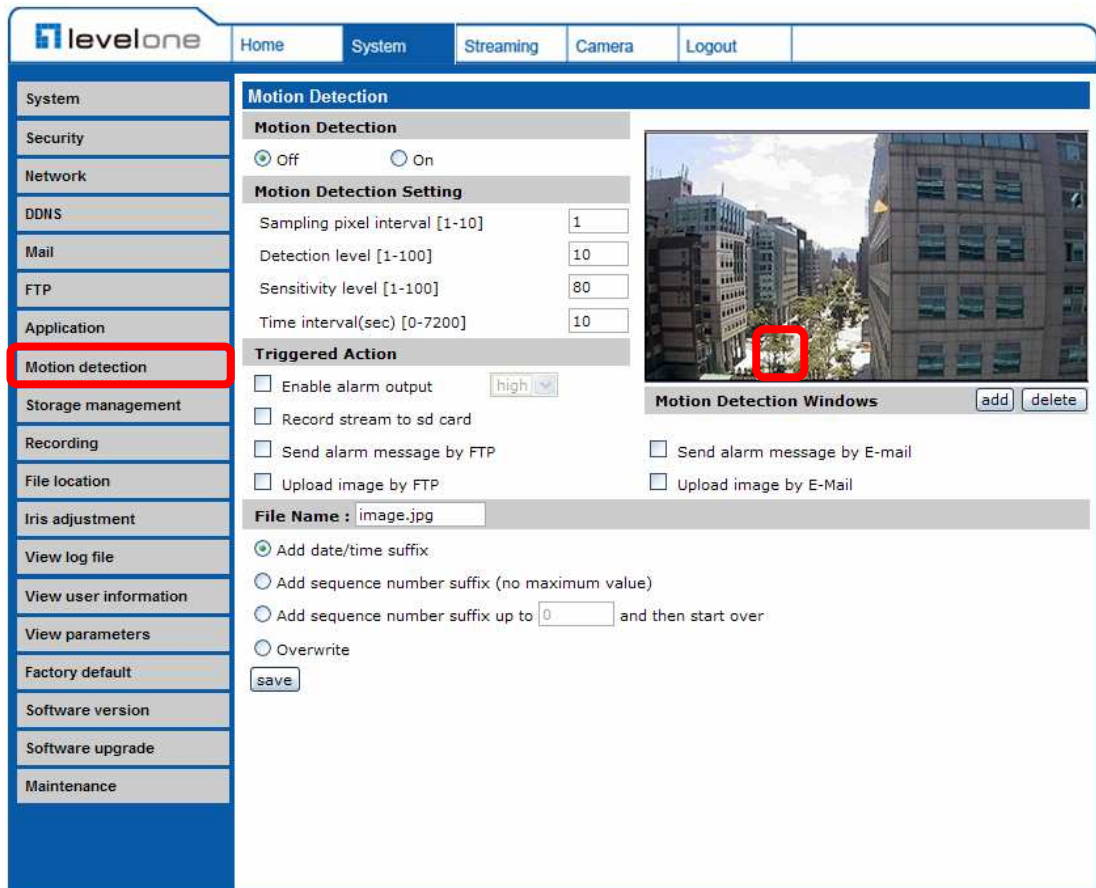

In the Motion Detection setting page, there is a frame (**Motion Detection Window**) displayed on the Live View Pane. The Motion Detection Window is for defining the motion detection area. To change the size of the Motion Detection Window, move the mouse cursor to the edge of the frame and draw it outward/inward. Moving the mouse to the center of the frame can shift the frame to the intended location.

Up to 10 Motion Detection Windows can be set. Press the “add” button under the Live View Pane to add a Motion Detection Window. To cancel a Motion Detection Window, move the mouse cursor to the selected Window, and click on the “delete” button.

If Motion Detection function is activated, the pop-off window (Motion) with indication of motion will be shown.



When motion is detected, the signals will be displayed on the Motion window as shown below.

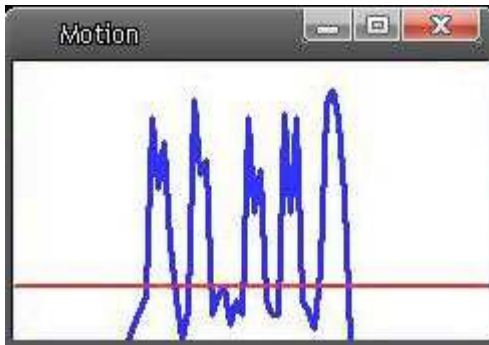

Detailed settings of Motion Detection are described as follows:

Motion Detection

You will be able to turn on/off Motion Detection in System section. Default setting is Off.

Motion Detection Setting

Users could adjust various parameters of Motion Detection in this section.

- Sampling pixel interval [1-100]:
The default value is 10, which means system will take one sampling pixel for every 10 pixel.
- Detection level [1-100]:
The default level is 10. The item is to set detection level for each sampling pixel; the smaller the value, the more sensitive it is.

- **Sensitivity level [1-100]:**
The default level is 80, which means if 20% or more sampling pixels are detected differently, system will detect motion. The bigger the value, the more sensitive it is. Meanwhile, when the value is bigger, the red horizontal line in the motion indication window will be lower accordingly.
- **Time interval (sec) [0-7200]:**
The default interval is 10. The value is the interval between each detected motion.

Triggered Action (Multi-option)

The Administrator can specify alarm actions that will take when motion is detected. All options are listed as follows:

- **Enable Alarm Output**
Check the item and select the predefined type of alarm output to enable alarm relay output when motion is detected.



NOTE: This option is excluded in the Compact IP Dome Camera.

- **Record stream to SD Card**
Select this item, and the Motion Detection recording will be stored in Micro SD/ SDHC card when motion is detected.



NOTE: Please make sure the local recording (with Micro SD/ SDHC card) is activated so that this function can be implemented. See section [4.3.10 Recording](#) for further details.

- **Send Alarm Message by FTP/E-Mail**
The Administrator can select whether to send an alarm message by FTP and/or E-Mail when motion is detected.
- **Upload Image by FTP**
Select this item, and the Administrator can assign a FTP site and configure various parameters as shown in the figure below. When motion is detected, event images will be uploaded to the appointed FTP site.

<input checked="" type="checkbox"/>	Upload Image by FTP	
	FTP address	FTP1 ▾
	Pre-trigger buffer	5 frames ▾
	Post-trigger buffer	5 frames ▾
<input type="checkbox"/>	Continue image upload	
<input checked="" type="radio"/>	Upload for	1 sec
<input type="radio"/>	Upload during the trigger active	
	Image frequency	Max. ▾ fps

- **Upload Image by E-Mail**

Select this item, and the Administrator can assign an e-mail address and configure various parameters as shown in the figure below. When motion is detected, event images will be sent to the appointed e-mail address.

<input checked="" type="checkbox"/>	Upload Image by E-Mail	
	E-Mail address	E-Mail 1 ▾
	Pre-trigger buffer	5 frames ▾
	Post-trigger buffer	5 frames ▾
<input type="checkbox"/>	Continue image upload	
<input checked="" type="radio"/>	Upload for	1 sec
<input type="radio"/>	Upload during the trigger active	
	Image frequency	Max. ▾ fps



NOTE: Make sure SMTP or FTP configuration has been completed. See section [4.3.5 Mail](#) and [4.3.6 FTP](#) for further details.

File Name

The uploaded image's filename format can be set in this section. Please select the one that meets your requirements.

Save

Click the Save button to save all the Motion Detection settings mentioned above.

4.3.9 Storage Management

Users can implement local recording to the Micro SD/SDHC card.



NOTE: Please format the Micro SD/SDHC card first before recording starts.

The screenshot shows the 'levelone' web interface. The top navigation bar includes 'Home', 'System', 'Streaming', 'Camera', and 'Logout'. The left sidebar contains a menu with items like 'System', 'Security', 'Network', 'DDNS', 'Mail', 'FTP', 'Application', 'Motion detection', 'Storage management' (highlighted with a red box), 'Recording', 'File location', 'Iris adjustment', 'View log file', 'View user information', 'View parameters', 'Factory default', 'Software version', 'Software upgrade', and 'Maintenance'. The main content area is titled 'Storage Management' and contains the following sections:

- Device information:** Device type: SD card; Free space: 0 KB; Total size: 0 KB; Status: No; Full: No.
- Device setting:** Format device: [Format button]
- Disk cleanup setting:** Enable automatic disk cleanup; Remove recordings older than: 1 day(s); Remove oldest recordings when disk is: 85 % full; [Save button]
- Recording list:** A table with columns 'FileName' and 'Size'. Below the table are buttons for 'Remove', 'Sort', and 'download'.

Device information

When users insert the Micro SD/SDHC card, the card information such as the memory capacity and status will be shown at Device Information section.

Device setting

Press the “Format” button to format the memory card.

Disk cleanup setting

Users can enable automatic recordings cleanup by specifying the time and storage limits

Recording List

Each video file on the Micro SD/SDHC card will be listed in the Recording list as shown below.

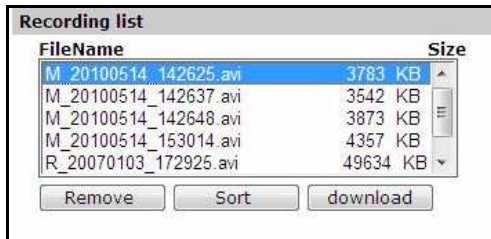

FileName	Size
M_20100514_142625.avi	3783 KB
M_20100514_142637.avi	3542 KB
M_20100514_142648.avi	3873 KB
M_20100514_153014.avi	4357 KB
R_20070103_172925.avi	49634 KB

Remove Sort download

- **Remove**

To remove a file, select the file first, and then press the “Remove” button.

- **Sort:**

Press the “Sort” button, and the files in the Recording list will be listed in name and date order.



NOTE: The capital letter A/M/R appears in the very beginning of name denotes the sort of the recording: A stands for Alarm; M stands for Motion; R stands for regular recording.

- **Download:**

To open/download a video clip, select the file first, and then press the “download” button below the Recording list field. The selected file window will pop up as shown below. Click on the AVI file to directly play the video in the player or download it to a specified location.



4.3.10 Recording

In the Recording setting page, users can specify the recording schedule that fits the present surveillance requirement.

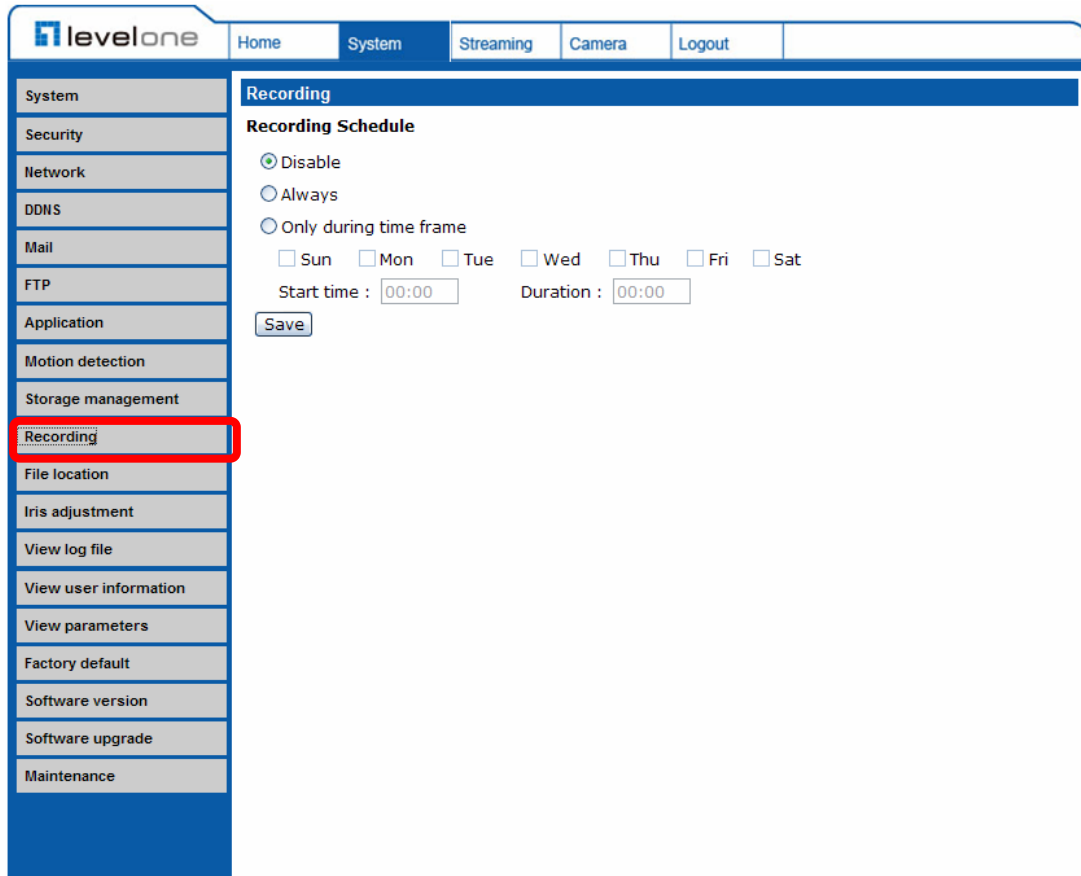

The screenshot displays the 'levelone' web interface. The top navigation bar includes 'Home', 'System', 'Streaming', 'Camera', and 'Logout'. A left sidebar lists various system settings, with 'Recording' highlighted in a red box. The main content area is titled 'Recording' and contains the 'Recording Schedule' configuration. It features three radio button options: 'Disable' (selected), 'Always', and 'Only during time frame'. Below these, there are checkboxes for each day of the week (Sun, Mon, Tue, Wed, Thu, Fri, Sat). The 'Start time' and 'Duration' are set to '00:00'. A 'Save' button is located at the bottom of the configuration area.

Activating Micro SD/SDHC Card Recording

Two types of schedule mode are offered: Always and Time Frame setting. Users can setup the time frame to fit the recording schedule or choose “Always” to activate Micro SD/SDHC Card Recording all the time.

Please click on the “Save” button for confirming the schedule mode.

Terminating Micro SD/SDHC Card Recording

Select “Disable” to terminate the recording function.

4.3.11 File Location

Users can specify a storage location for the snapshots and live video recording. The default setting is: C:\. Once confirm the setting, press “Save,” and all the snapshots and recording will be saved in the designate location.



NOTE: Please make sure the selected file path contains valid characters such as letters and numbers.

The screenshot shows the 'levelone' web interface. The top navigation bar includes 'Home', 'System', 'Streaming', 'Camera', and 'Logout'. A left sidebar menu lists various system settings, with 'File location' highlighted by a red rectangle. The main content area is titled 'File Location' and contains the instruction 'Set the destination of snapshot photos and recorded video files'. Below this, there is a label 'All files stored at:' followed by a text input field containing 'C:\' and a 'Select' button. A 'Save' button is positioned below the input field.

4.3.12 Iris Adjustment (Excluding Compact IP Dome)

For users who use Auto-iris lens, when it is required to implement iris adjustment, please refer to the Iris adjustment procedure in the setting page to adjust iris.

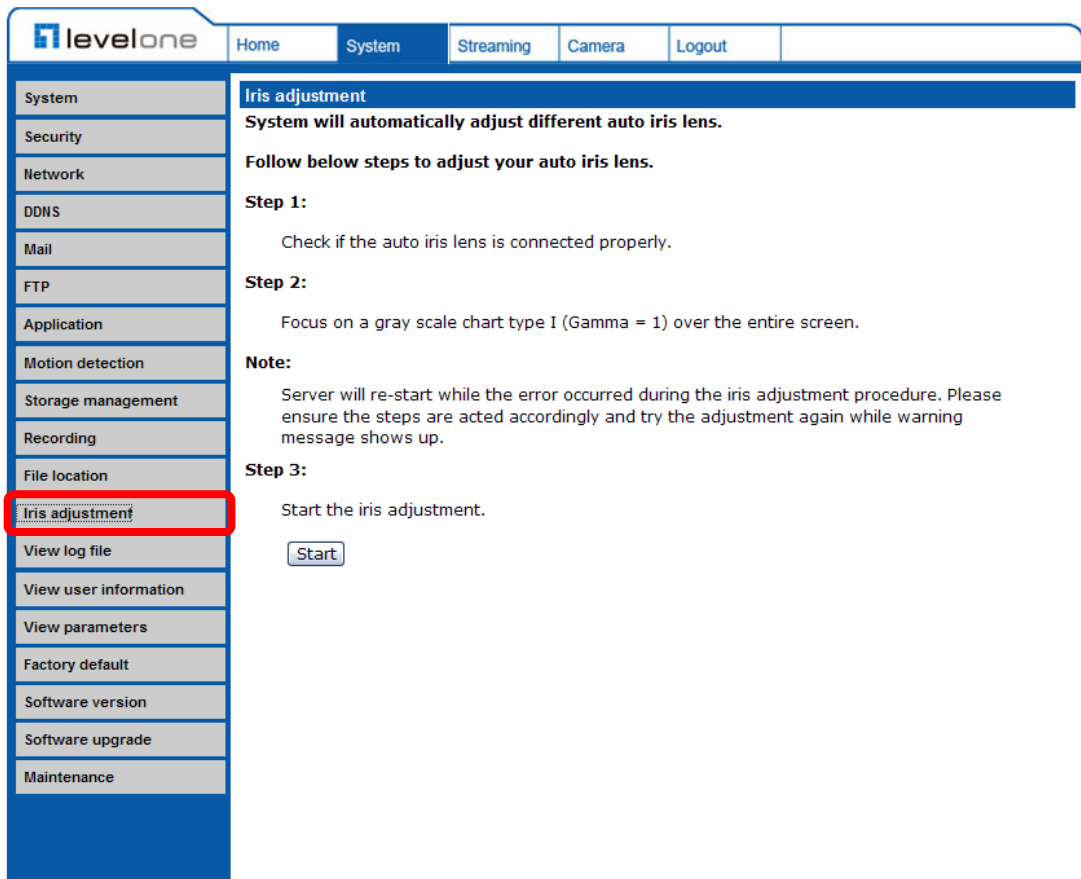

The screenshot shows the LevelOne web interface. The top navigation bar includes 'Home', 'System', 'Streaming', 'Camera', and 'Logout'. The left sidebar contains a list of system settings, with 'Iris adjustment' highlighted in a red box. The main content area is titled 'Iris adjustment' and contains the following text:

Iris adjustment
System will automatically adjust different auto iris lens.
Follow below steps to adjust your auto iris lens.

Step 1:
Check if the auto iris lens is connected properly.

Step 2:
Focus on a gray scale chart type I (Gamma = 1) over the entire screen.

Note:
Server will re-start while the error occurred during the iris adjustment procedure. Please ensure the steps are acted accordingly and try the adjustment again while warning message shows up.

Step 3:
Start the iris adjustment.

4.3.13 View Log File

Click on the link to view the system log file. The content of the file provides useful information about configuration and connections after system boot-up.

The screenshot shows the 'levelone' web interface. The top navigation bar includes 'Home', 'System', 'Streaming', 'Camera', and 'Logout'. The left sidebar contains a list of menu items: System, Security, Network, DDNS, Mail, FTP, Application, Motion detection, Storage management, Recording (highlighted with a red box), File location, Iris adjustment, View log file, View user information, View parameters, Factory default, Software version, Software upgrade, and Maintenance. The main content area is titled 'System log' and displays a list of system events:

```
[Mon Jan 1 00:00:00 2007] --Network interface initialized start
[Mon Jan 1 00:00:12 2007] --Network interface initialized end
[Mon Jan 1 00:00:12 2007] --Subnet Mask = 255.255.255.0
[Mon Jan 1 00:00:12 2007] --Host IP = 192.168.50.143
[Mon Jan 1 00:00:12 2007] --Gateway =
[Mon Jan 1 00:00:12 2007] --MAC address = 00:D0:89:05:31:4C
[Mon Jan 1 00:00:30 2007] --connect by root@192.168.50.115
[Mon Jan 1 00:00:34 2007] --connect by root@192.168.50.115
[Mon Jan 1 00:01:03 2007] --connect by root@192.168.50.115
[Mon Jan 1 00:01:23 2007] --connect by root@192.168.50.115
[Mon Jan 1 00:01:23 2007] --connect by root@192.168.50.115
[Mon Jan 1 00:01:30 2007] --connect by root@192.168.50.115
[Mon Jan 1 00:01:30 2007] --connect by root@192.168.50.115
[Mon Jan 1 00:02:57 2007] --connect by root@192.168.50.115
```

4.3.14 View User Information

The Administrator can view each added user's login information and privileges (see [4.3.2 Security](#)).

View User Login Information

All the users in the network will be listed in the "User information" zone, as shown below. As the figure below shows:

root:

It indicates that one user's login username is: root, and the password is blank.

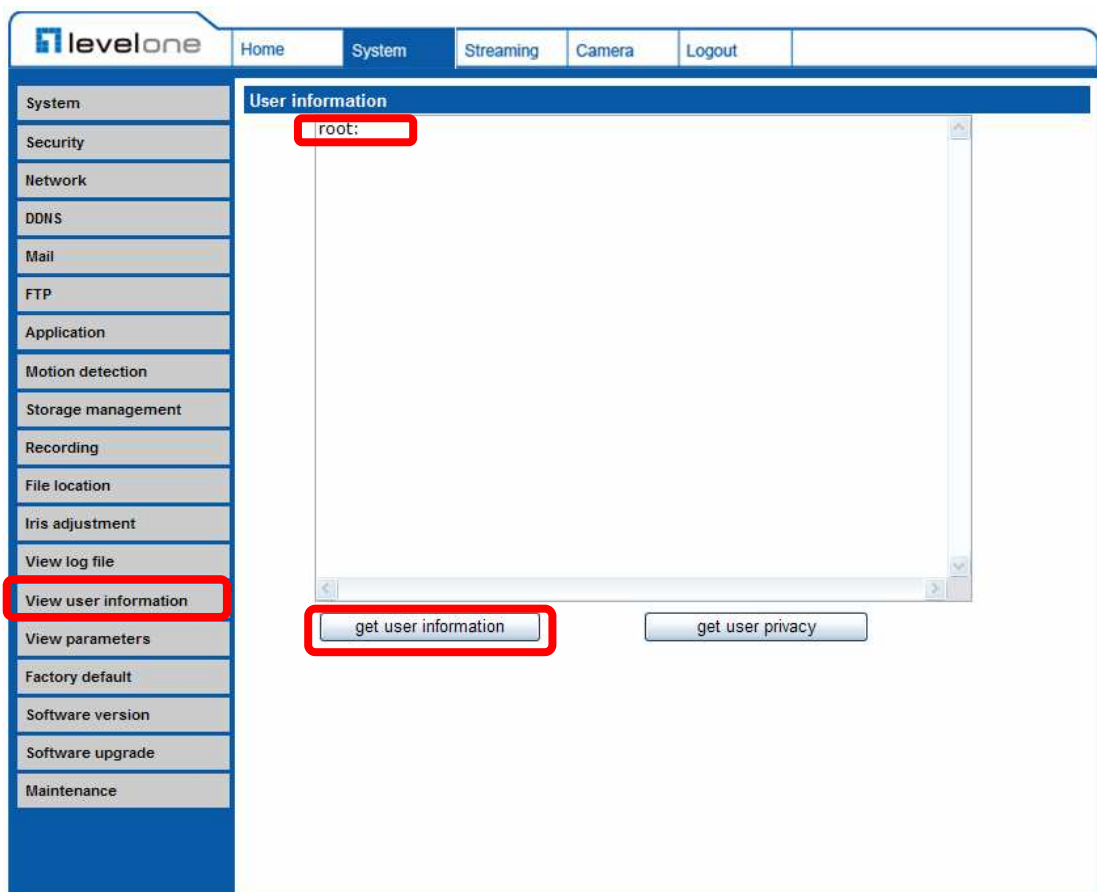

View User Privilege

Press “get user privacy” down the page, and the Administrator can view each user’s privileges.

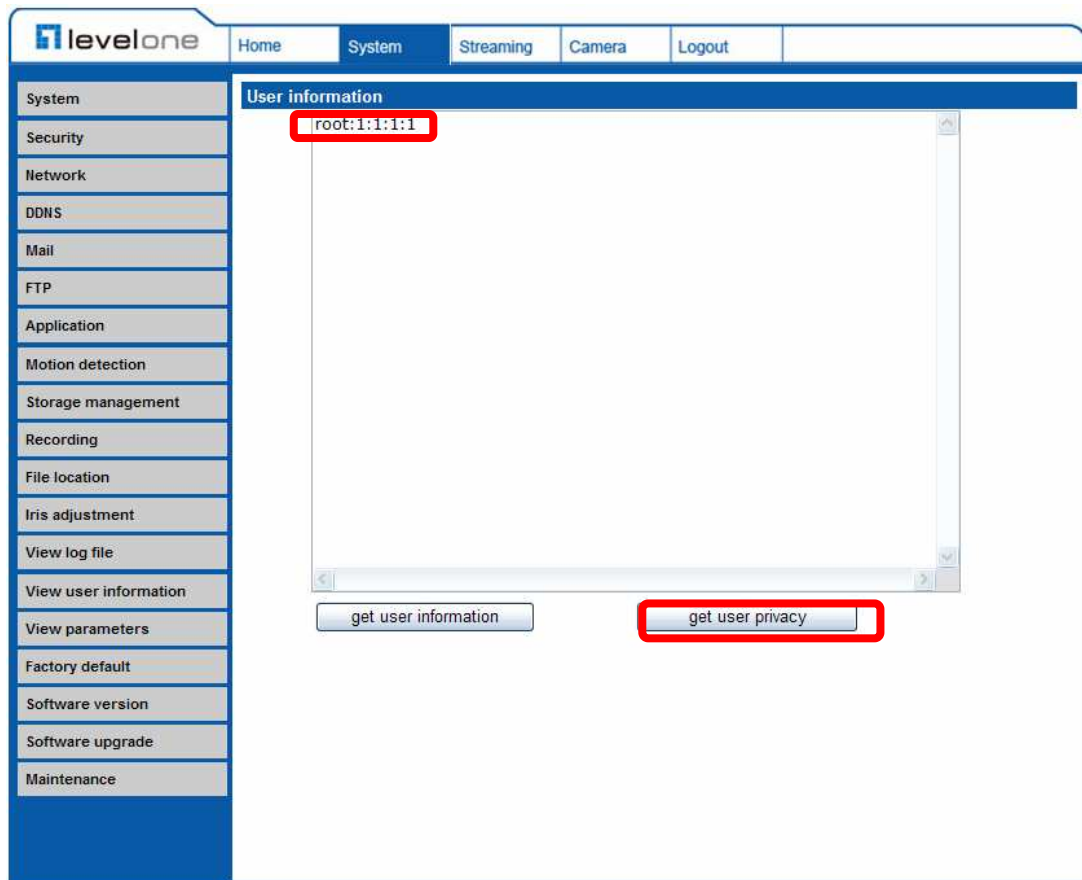

As the figure above shows:

User: 1:1:0:1

1:1:0:1= I/O access : Camera control : Talk : Listen (see [4.3.2 Security](#))

<input checked="" type="checkbox"/> I/O access	<input checked="" type="checkbox"/> Camera control
<input type="checkbox"/> Talk	<input checked="" type="checkbox"/> Listen

Therefore, it denotes the user is granted privileges of I/O access, Camera control and Listen.

4.3.15 View Parameters

Click on this item to view the entire system's parameter setting.

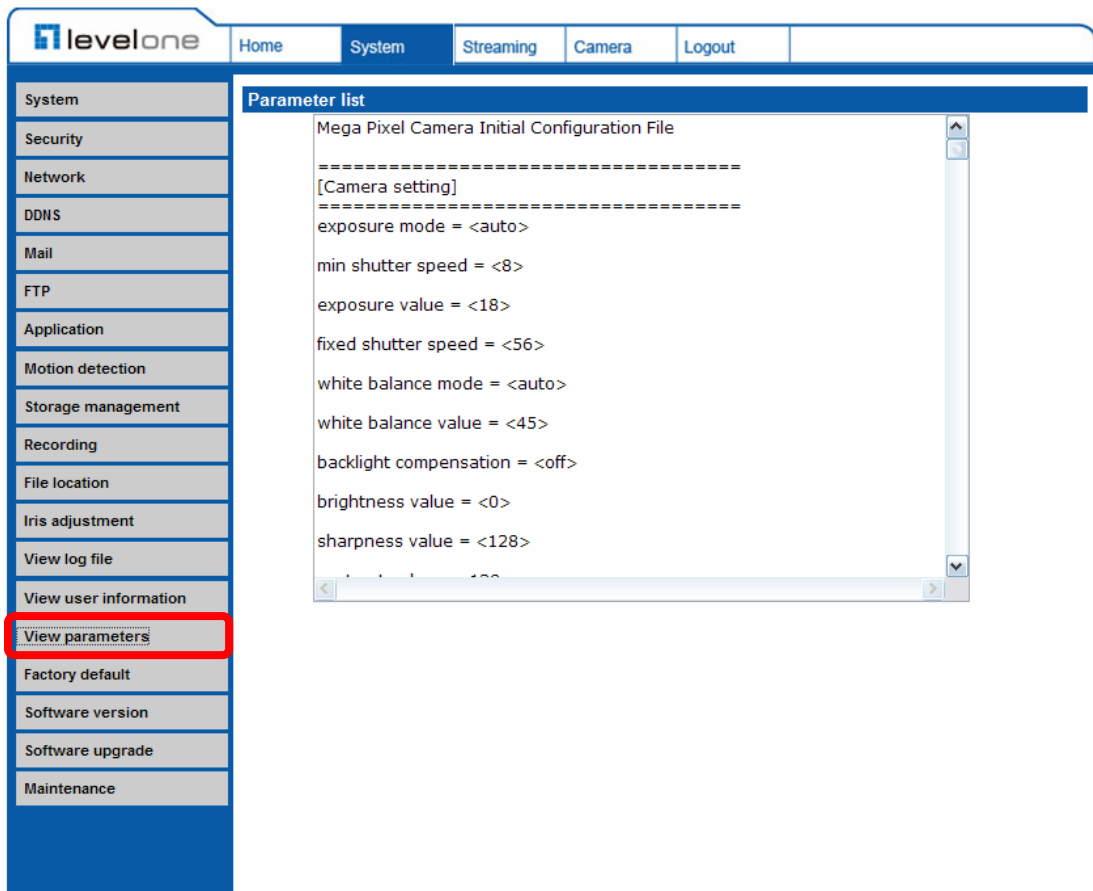

The screenshot shows the 'levelone' web interface. The top navigation bar includes 'Home', 'System', 'Streaming', 'Camera', and 'Logout'. The left sidebar contains a list of menu items: System, Security, Network, DDNS, Mail, FTP, Application, Motion detection, Storage management, Recording, File location, Iris adjustment, View log file, View user information, View parameters (highlighted with a red box), Factory default, Software version, Software upgrade, and Maintenance. The main content area is titled 'Parameter list' and displays the following configuration details:

```
Mega Pixel Camera Initial Configuration File
=====
[Camera setting]
=====
exposure mode = <auto>
min shutter speed = <8>
exposure value = <18>
fixed shutter speed = <56>
white balance mode = <auto>
white balance value = <45>
backlight compensation = <off>
brightness value = <0>
sharpness value = <128>
```

4.3.16 Factory Default

The factory default setting page is shown as below. Follow the instructions to reset the IP Camera to factory default setting if needed.

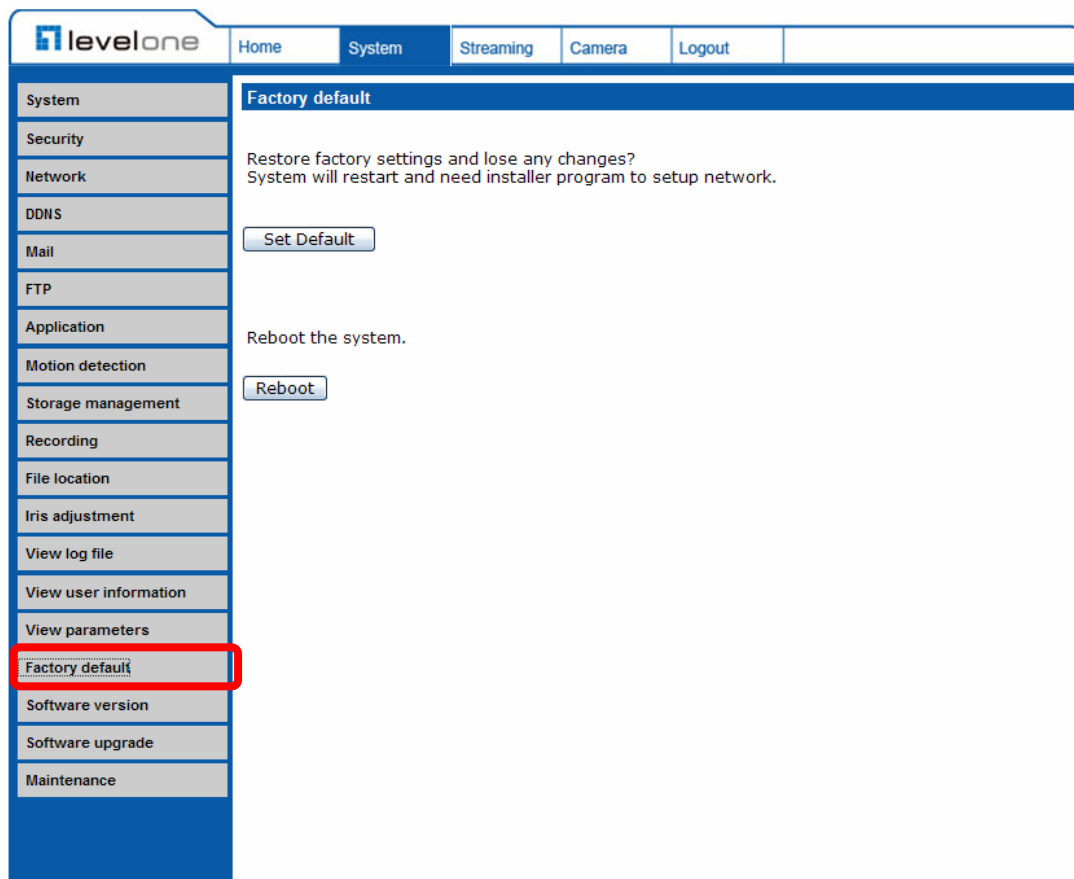

Set Default

Click on the “Set Default” button to recall the factory default settings. Then the system will restart in 30 seconds.



NOTE: The IP address will be restored to default.

Reboot

Click on the “Reboot” button, and the system will restart without changing current settings.

4.3.17 Software Version

The current software version is displayed in the software version page, which is shown as the figure below.

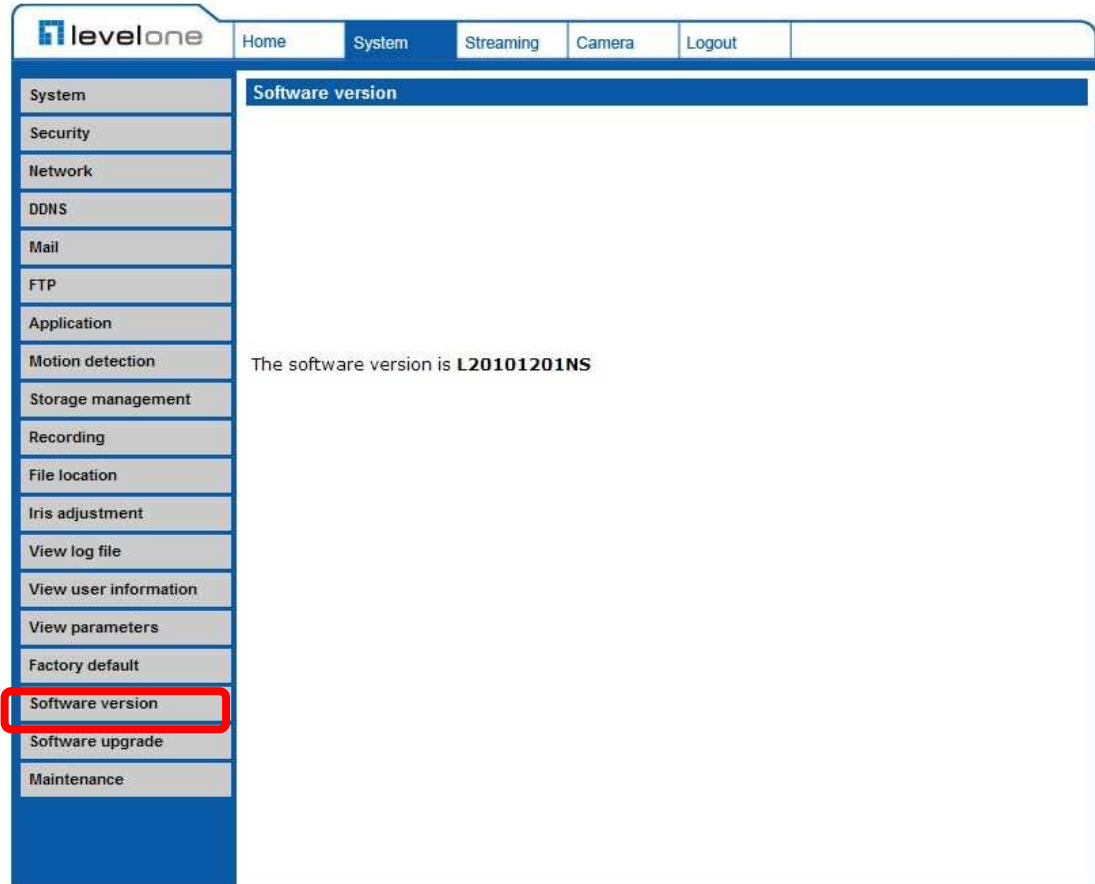

4.3.18 Software Upgrade

Software upgrade can be carried out in the “Software Upgrade” page, as shown below.

The screenshot shows the LevelOne web interface. The top navigation bar includes 'Home', 'System', 'Streaming', 'Camera', and 'Logout'. The left sidebar contains a list of menu items: System, Security, Network, DDNS, Mail, FTP, Application, Motion detection, Storage management, Recording, File location, Iris adjustment, View log file, View user information, View parameters, Factory default, Software version, Software upgrade (highlighted with a red box), and Maintenance. The main content area is titled 'Upgrade' and contains the following instructions:

Follow These Steps To Do The Software Upgrade

Step1:
Upload the binary file

Step2:
Select binary file you want to upgrade

Step3:
Click the upgrade button to start the upgrade process



NOTE: Make sure the upgrade software file is available before carrying out software upgrade.

The procedure of software upgrade is like the following:

Step 1: Click “Browse” and select the binary file to be uploaded, ex. Userland.jffs2.

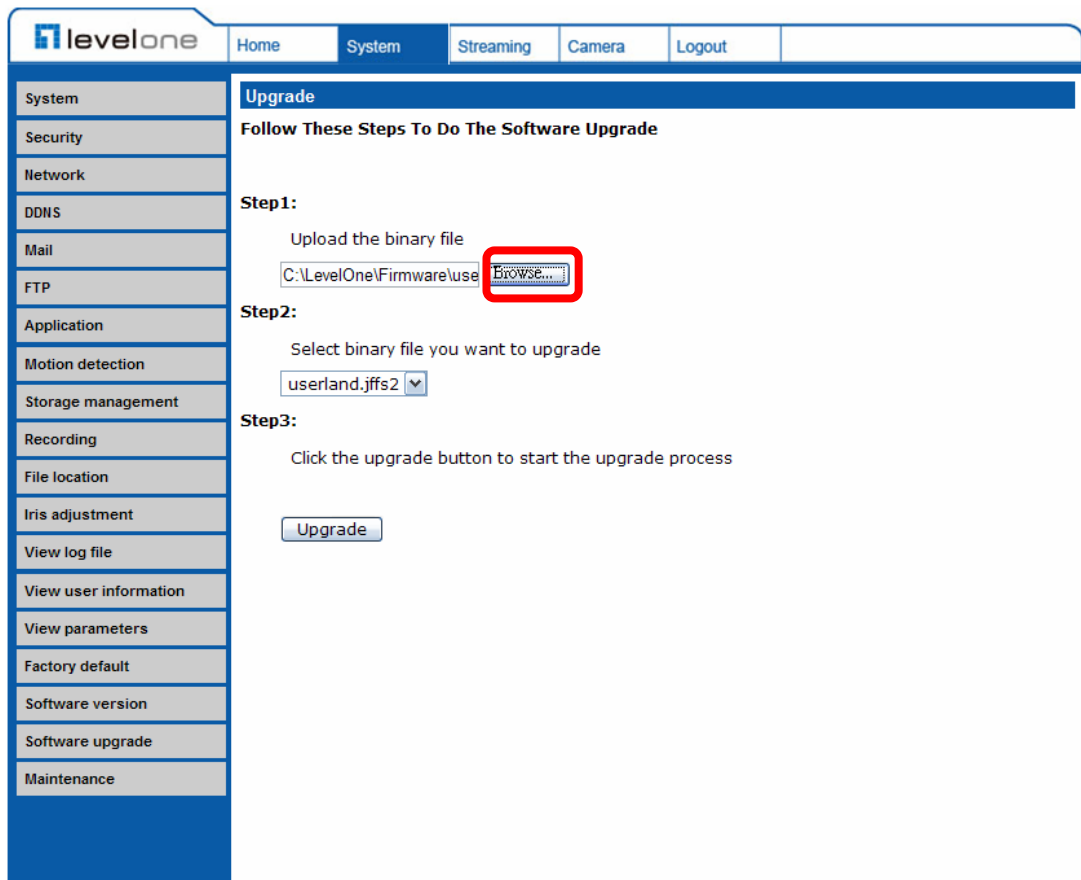

The screenshot shows the LevelOne web interface. The navigation menu on the left includes System, Security, Network, DDNS, Mail, FTP, Application, Motion detection, Storage management, Recording, File location, Iris adjustment, View log file, View user information, View parameters, Factory default, Software version, Software upgrade, and Maintenance. The main content area is titled "Upgrade" and contains the following steps:

- Step1:** Upload the binary file. A text input field contains "C:\LevelOne\Firmware\use" and a "Browse..." button is highlighted with a red box.
- Step2:** Select binary file you want to upgrade. A dropdown menu shows "userland.jffs2".
- Step3:** Click the upgrade button to start the upgrade process. An "Upgrade" button is visible.



NOTE: Do not change the upgrade file name, or the system will fail to find the file.

Step 2: Pull down the upgrade binary file list and select the file you want to upgrade; in this case, select “userland.jffs2.”

Step 3: Press “Upgrade”. The system will first check whether the upgrade file exists or not, and then begin to upload the upgrade file. Subsequently, the upgrade status bar will display on the page. When it runs to 100%, the upgrade process is finished.

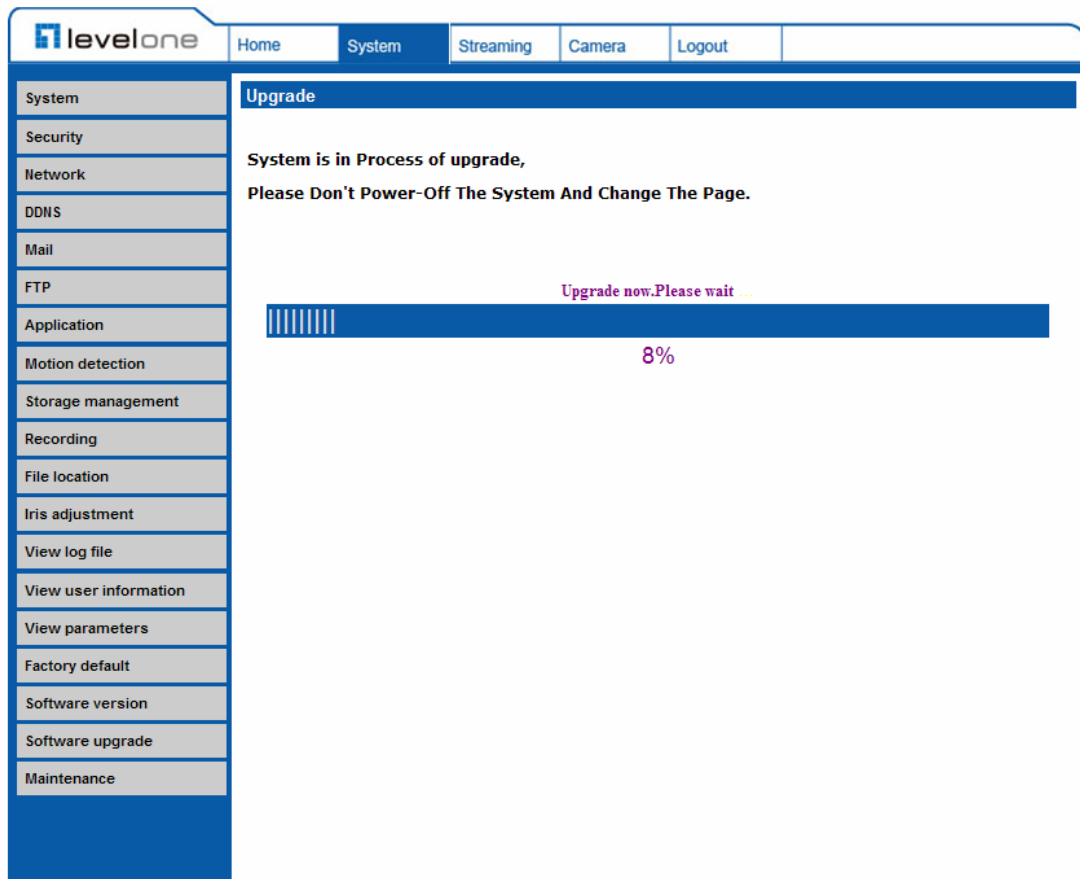

After the upgrade process is finished, the viewer will return to Home page.

Step 4: Close the video browser.

Step 5: Click “Control Panel”, and then double click “Add or Remove Programs.” In the “Currently install programs” list, select “DCViewer” and click the button “Remove” to uninstall the existing DC Viewer.

Step 6: Open a new web browser, re-login the IP Camera, and then allow the automatic download of DC Viewer.

4.3.19 Maintenance

Users can export configuration files to a specified location and retrieve data by uploading an existing configuration file to the IP Camera.

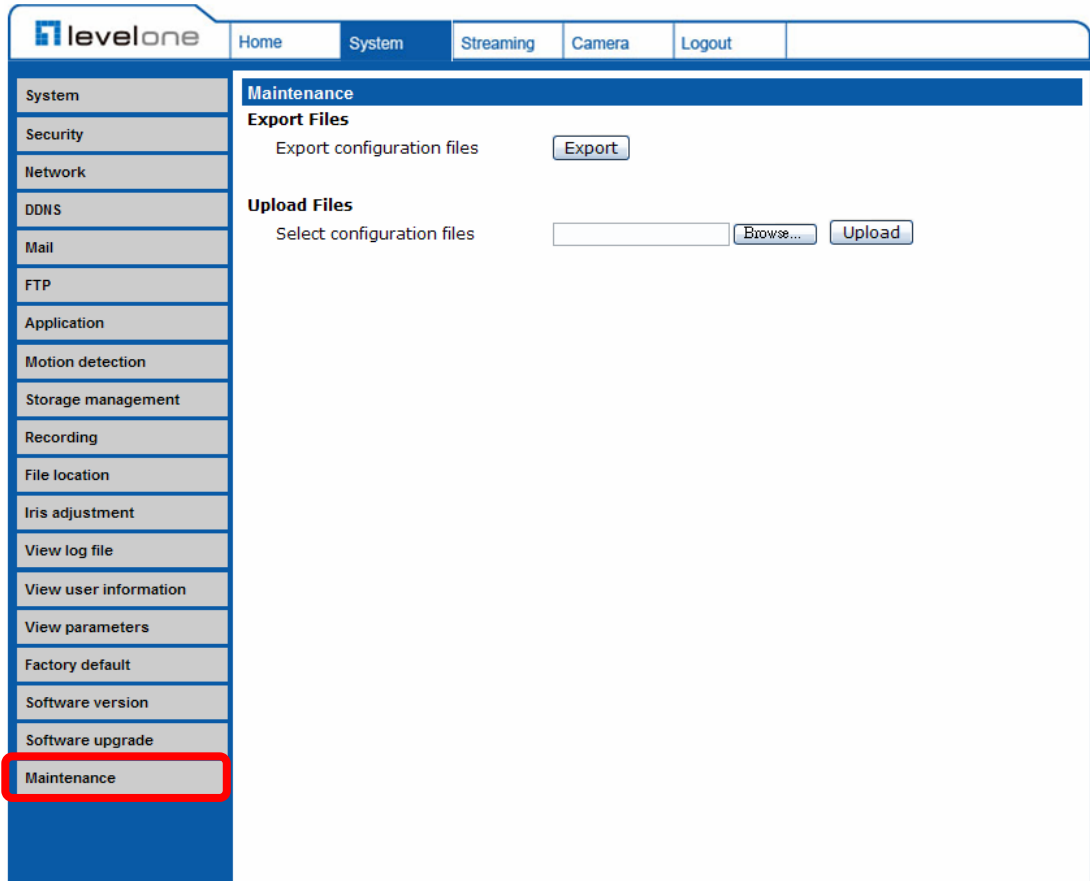

Export

Users can save the system settings by exporting the configuration file (.bin) to a specified location for future use. Press the “Export” button, and the popup File Download window will come out as shown below. Click “Save” and specify a desired location for saving the configuration file.



Upload

To copy an existing configuration file to the IP Camera, please first click on “Browse” to select the configuration file, and then press the “Upload” button for uploading.

4.4 Video and Audio Streaming Settings

Press the tab “Streaming” in the top of the page, and the configurable video and audio items will display in the left column. In Streaming, the Administrator can configure specific video resolution, video compression mode, video protocol, audio transmission mode, etc. Further details of these settings will be specified in the following sections.

4.4.1 Video Resolution and Rotate Type

The video setting page is shown below:

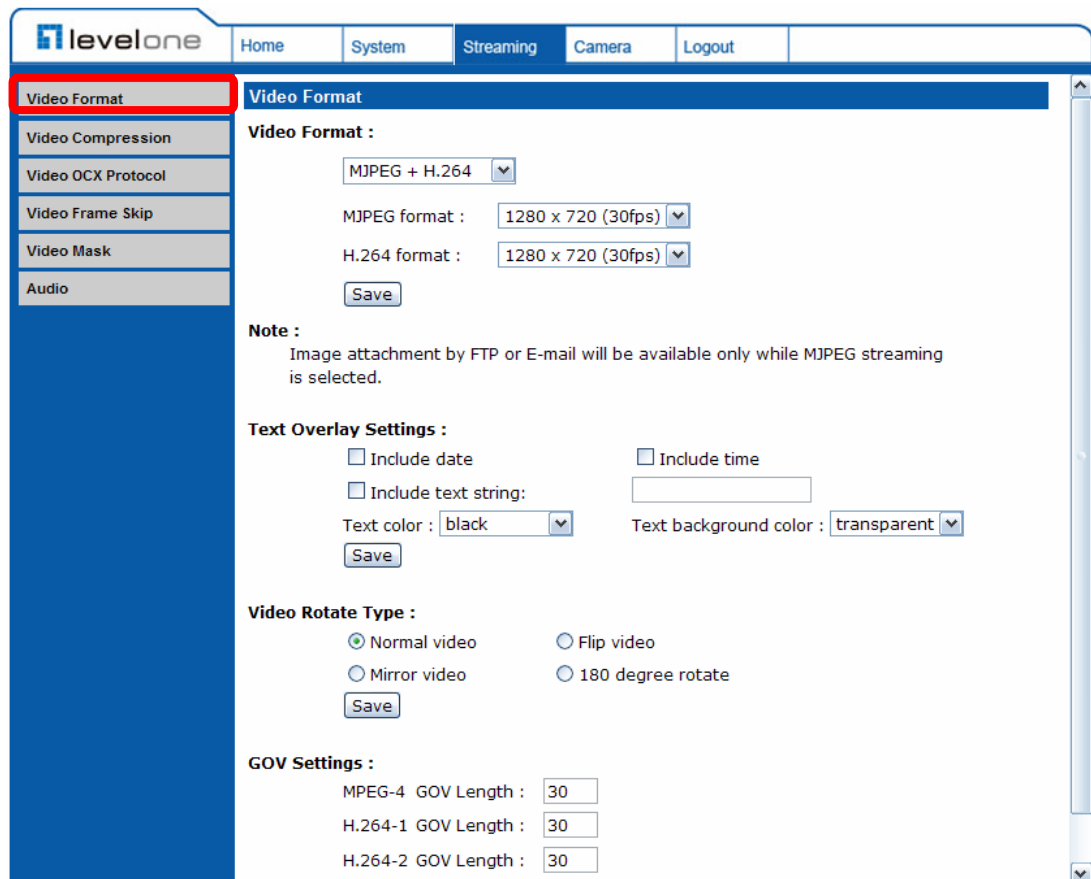

The screenshot displays the LevelOne web interface for video settings. The top navigation bar includes 'Home', 'System', 'Streaming', 'Camera', and 'Logout'. The left sidebar contains a menu with 'Video Format' highlighted in red, along with 'Video Compression', 'Video OCX Protocol', 'Video Frame Skip', 'Video Mask', and 'Audio'. The main content area is titled 'Video Format' and contains the following sections:

- Video Format :** A dropdown menu is set to 'MJPEG + H.264'. Below it, 'MJPEG format :' is set to '1280 x 720 (30fps)' and 'H.264 format :' is also set to '1280 x 720 (30fps)'. A 'Save' button is present.
- Note :** A text block stating: 'Image attachment by FTP or E-mail will be available only while MJPEG streaming is selected.'
- Text Overlay Settings :** Includes checkboxes for 'Include date' and 'Include time'. There is an 'Include text string:' label followed by an empty text input field. Below these are dropdown menus for 'Text color : black' and 'Text background color : transparent', with a 'Save' button.
- Video Rotate Type :** Features four radio button options: 'Normal video' (selected), 'Flip video', 'Mirror video', and '180 degree rotate'. A 'Save' button is located below.
- GOV Settings :** Lists three GOV Length settings, each with a text input field containing the value '30':
 - MPEG-4 GOV Length : 30
 - H.264-1 GOV Length : 30
 - H.264-2 GOV Length : 30

Video Format

Resolution for MJPEG & H.264 format includes:

- H.264 720p (30fps) + MJPEG 720p (30fps)
- H.264 720p (30fps) + MJPEG D1 (30fps)
- H.264 720p (30fps) + MJPEG CIF (30fps)
- H.264 720p (30fps) + H.264 D1 (30fps)
- H.264 720p (30fps) + H.264 CIF (30fps)
- MJPEG 1080p (15fps)
- H.264 1080p (15fps)
- MJPEG 720p (15fps)+BNC Output

Click “Save” to confirm the setting.



NOTE: BNC Output is only available for Box Camera and Vandal Proof Dome.

Text Overlay Settings

Users can select the items to display data including date/time/text on the live video pane. The maximum length of the string is 20 alphanumeric characters.

Click “Save” to confirm the Text Overlay setting.

Video Rotate Type

Users can change video display type if necessary. Selectable video rotate types include Normal, Flip, Mirror and 180 degree. Differences among these types are illustrated as below.

Suppose the displayed image of IP Camera is shown as the figure below.



To rotate the image, users can select “Flip”, for instance. Then the displayed image will be reversed as shown below.

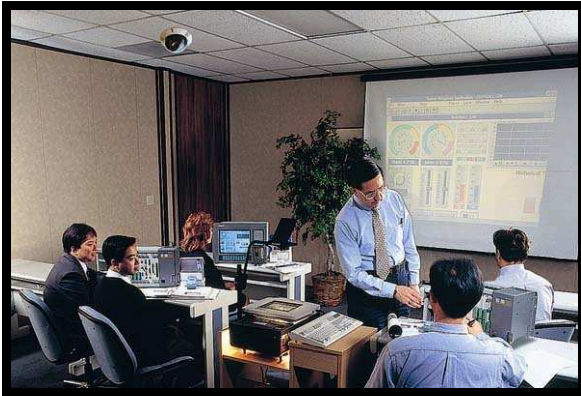

The following is descriptions for different video rotate type.

- **Flip**
If select <Flip>, the image will be rotated vertically.
- **Mirror**
If select <Mirror>, the image will be rotated horizontally.
- **180 Degree**
Selecting <180 Degree> will make the image 180° counter-/clockwise inversed.

Click “Save” to confirm the setting.

GOV Settings

Users can set the GOV length to determine the frame contracture (I-frames and P-frames) in a video stream for saving bandwidth. Longer GOV means decreasing the frequency of I-frames.

Click “Save” to confirm the GOV setting.

4.4.2 Video Compression

Users can select a proper MJPEG/H.264 compression mode in the video compression page (see the figure below), depending on the application.

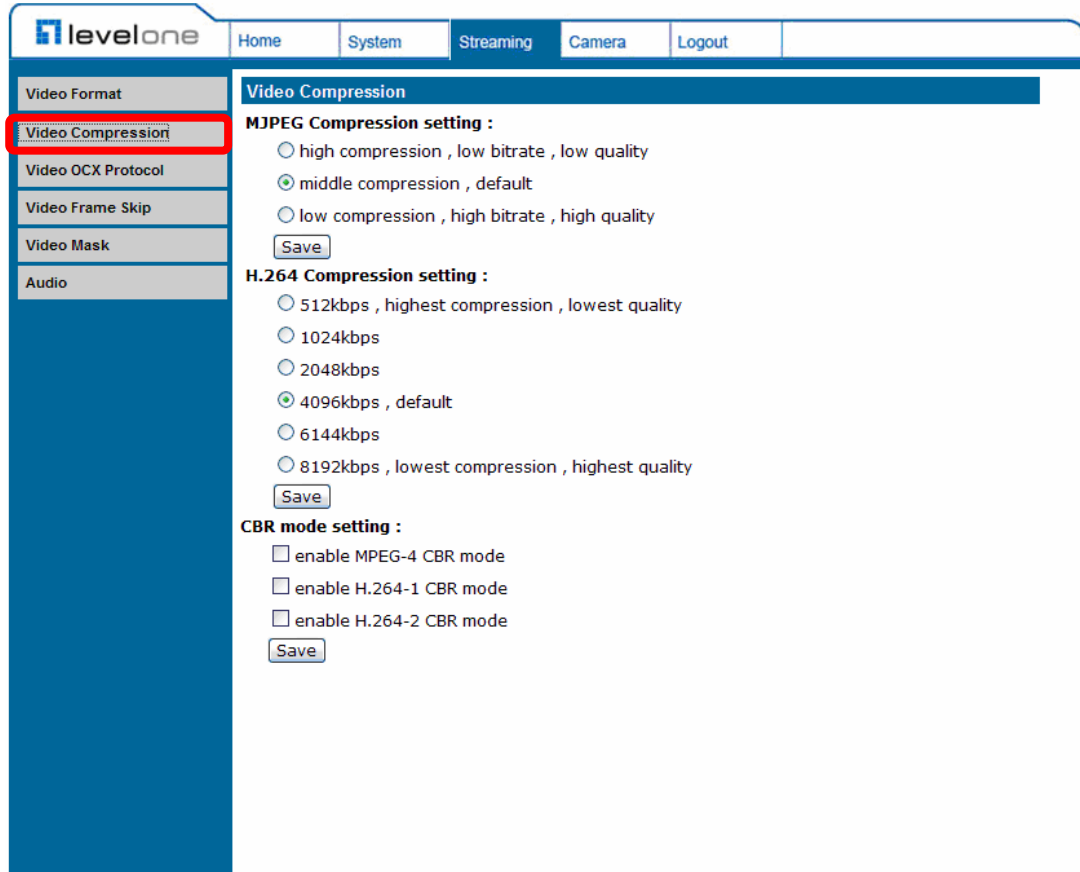

Users can also decide whether to display compression information on the Home page.

Click "Save" to confirm the setting.

CBR Mode Setting

The screenshot shows the 'levelone' web interface with the 'Streaming' tab selected. The left sidebar contains a menu with 'Video Compression' highlighted. The main content area is titled 'Video Compression' and contains three sections: 'MJPEG Compression setting', 'H.264 Compression setting', and 'CBR mode setting'. The 'CBR mode setting' section is highlighted with a red box and contains three checkboxes: 'enable MPEG-4 CBR mode', 'enable H.264-1 CBR mode', and 'enable H.264-2 CBR mode'. Each section has a 'Save' button below it.

levelone Home System Streaming Camera Logout

Video Compression

MJPEG Compression setting :

- high compression , low bitrate , low quality
- middle compression , default
- low compression , high bitrate , high quality

H.264 Compression setting :

- 512kbps , highest compression , lowest quality
- 1024kbps
- 2048kbps
- 4096kbps , default
- 6144kbps
- 8192kbps , lowest compression , highest quality

CBR mode setting :

- enable MPEG-4 CBR mode
- enable H.264-1 CBR mode
- enable H.264-2 CBR mode

The CBR (Constant Bit Rate) mode could be the preferred bit rage mode if the bandwidth available is limited. It is important to take account of image quality while choosing to use CBR mode.

4.4.3 Video OCX Protocol

In the Video OCX protocol setting page, users can select RTP over UDP, RTP over TCP, RTSP over HTTP or MJPEG over HTTP, for streaming media over the network. In the case of multicast networking, users can select the Multicast mode. The page is shown as follows.

The screenshot shows the 'levelone' web interface. The top navigation bar includes 'Home', 'System', 'Streaming', 'Camera', and 'Logout'. The left sidebar contains menu items: 'Video Format', 'Video Compression', 'Video OCX Protocol' (highlighted with a red box), 'Video Frame Skip', 'Video Mask', and 'Audio'. The main content area is titled 'Video OCX Protocol' and contains the following settings:

Video OCX protocol setting :

- RTP over UDP
- RTP over RTSP(TCP)
- RTSP over HTTP
- MJPEG over HTTP
- Multicast mode

Below the radio buttons are several input fields for multicast settings:

- Multicast IP Address:
- Multicast MPEG-4 Video Port:
- Multicast H.264-1 Video Port:
- Multicast H.264-2 Video Port:
- Multicast MJPEG Video Port:
- Multicast Audio Port:
- Multicast TTL:

A 'Save' button is located below the input fields. A 'Note:' section at the bottom states: 'This page only applies to video streams going to a DC Viewer.'

Video OCX protocol setting options include:

- RTP over UDP / RTP over RTSP(TCP) / RTSP over HTTP / MJPEG over HTTP

Select a mode according to your data delivery requirements.

- Multicast Mode
Enter all required data, including multicast IP address, H.264 video port, MJPEG video port, audio port and TTL into each blank.

Click "Save" to confirm the setting.

4.4.4 Video Frame Skip

Video frame skipping is for saving bandwidth if necessary. The setting page is shown as below.

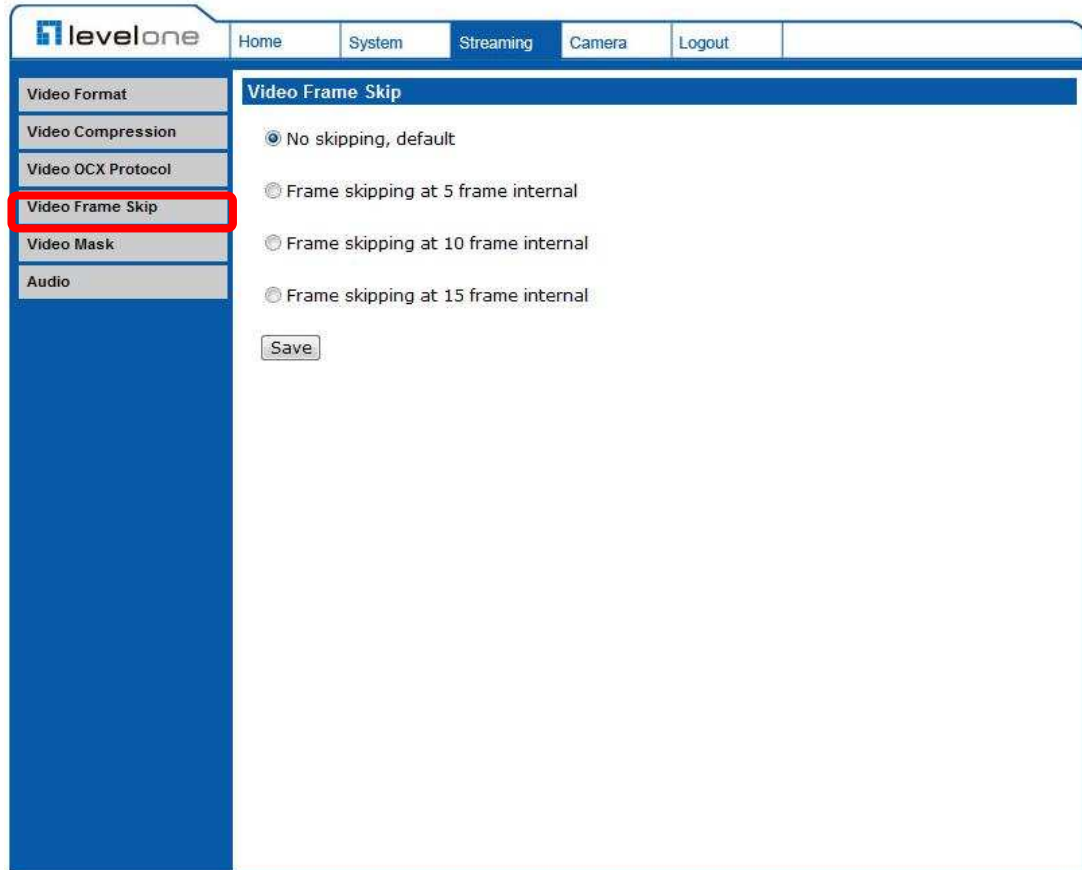

Video Frame Skip options include:

- No skipping, default
- Frame skipping at 5 frame internal
- Frame skipping at 10 frame internal
- Frame skipping at 15 frame internal



NOTE: Higher frame skipping rate will decrease video smoothness.

4.4.5 Video Mask

There are up to five video masks can be set by users.

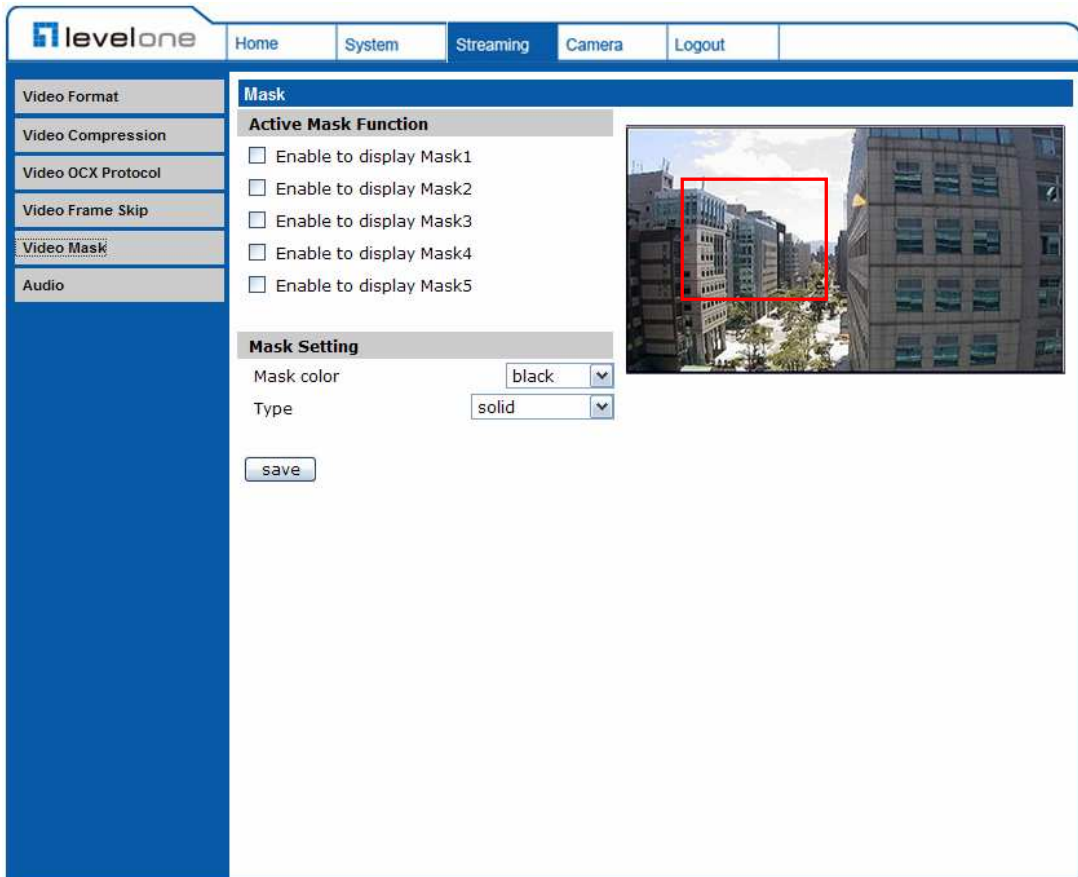

Active Mask Function

- **Add a Mask**

Check a Video Mask checkbox, and a red frame will come out in the Live Video pane at the right side. Use the mouse to drag and drop to adjust the mask's size and place it on the target zone.



NOTE: It is suggested to set the Video Mask twice bigger than the object.

- **Cancel a mask**

Uncheck the checkbox of the Video Mask meant to be deleted, and the selected mask will disappear from the Live Video pane instantly.

Mask Setting

- **Mask color**
The selections of Mask color include red, black, white, yellow, green, blue, cyan, and magenta.
- **Type**
Select to change the mask type as solid or transparent.

4.4.6 Audio Mode and Bit Rate Settings

The audio setting page is show as below. In the Audio page, the Administrator can select one transmission mode and audio bit rate.

The screenshot displays the 'levelone' web interface. The top navigation bar includes 'Home', 'System', 'Streaming', 'Camera', and 'Logout'. On the left, a sidebar lists various settings, with 'Audio' highlighted in a red box. The main content area, titled 'Audio', contains the following configuration options:

- Transmission Mode:** Radio buttons for 'Full-duplex (Talk and listen simultaneously)', 'Half-duplex (Talk or listen, not at the same time)', 'Simplex (Talk only)', 'Simplex (Listen only)', and 'Disable' (which is selected).
- Server Gain Setting:** 'Input gain' and 'Output gain' dropdown menus, both set to '3'.
- Bit Rate:** A dropdown menu set to 'uLAW'.
- A 'Save' button is positioned at the bottom of the settings area.

Transmission Mode

- **Full-duplex (Talk and Listen simultaneously)**
In the Full-duplex mode, the local and remote sites can communicate with each other simultaneously, i.e. both sites can speak and be heard at the same time.



NOTE: This option is only available in the Box Camera and Vandal Proof Dome.

- **Half-duplex (Talk or Listen, not at the same time)**

In the Half-duplex mode, the local/remote site can only talk or listen to the other site at a time.



NOTE: This option is only available in the Box Camera and Vandal Proof Dome.

- **Simplex (Talk only)**

In the Talk only Simplex mode, the local/remote site can only talk to the other site.



NOTE: This option is only available in the Box Camera and Vandal Proof Dome.

- **Simplex (Listen only)**

In the Listen only Simplex mode, the local/remote site can only listen to the other site.

- **Disable**

Select the item to turn off the audio transmission function.

Server Gain Setting

Set the audio input/output gain levels for sound amplification. The audio gain values are adjustable from 1 to 6. The sound will be turned off if the audio gain is set to “Mute”.

Bit Rate

Selectable audio transmission bit rate include 16 kbps (G.726), 24 kbps (G.726), 32 kbps (G.726), 40 kbps (G.726), uLAW (G.711) and ALAW (G.711). Both uLAW and ALAW signify 64 kbps but in different compression formats. Higher bit rate will let higher audio quality and require bigger bandwidth.

Click “Save” to confirm the setting.

4.5 Camera Settings

The figure below is the camera configuration page. Details of each parameter setting are described in the following subsections.

The screenshot displays the LevelOne camera configuration page. The top navigation bar includes 'Home', 'System', 'Streaming', 'Camera', and 'Logout'. The left sidebar contains various camera settings, each with a 'SET' button: Exposure, White Balance, Backlight (off), Brightness (1), Sharpness (6), Contrast (6), Saturation (6), Digital Zoom (x1), IR function (Auto), WDR Function (Off), 3DNR (Off), and TV System (30 fps(NTSC)). The main content area features a live video feed of a city street with a timestamp '2007/01/01 03:54'. Below the video, there are controls for 'Video format' (MJPEG and H.264), zoom levels (x1, x1/2, Full), and a 'Talk' button. Bitrate information is shown: 'MJPEG bitrate: middle compression, middle quality' and 'H.264 bitrate: low compression, high quality, 4096kbps'.



NOTE: Camera settings and function buttons will vary depending on the camera model.

4.5.1 Exposure Setting

The Exposure pull-down menu is shown as follows:

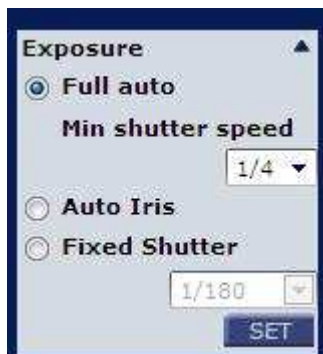

The exposure is the amount of light received by the image sensor and is determined by the width of lens diaphragm opening, the amount of exposure by the sensor (shutter speed) and other exposure parameters. With this item, users can define how the Auto Exposure function works.

Each exposure mode is specified as follows:

Full Auto Mode

In this mode, the camera's Shutter Speed, IRIS and AGC (Auto Gain Control) control circuits work together automatically to get consistent video output level. The shutter speed range is from 1 to 1/8 sec. with 4 options. Users could select suitable shutter speed according to the environmental illuminance.



NOTE: The minimum shutter speed set in the Full Auto Mode will be applied to **Auto Iris Mode**.

Auto Iris

In this mode, the exposure gives priority to the auto iris. Shutter speed and AGC circuit will function automatically in cooperating with IRIS to get consistent exposure output.



NOTE: The minimum shutter speed will vary depending on the setting in **Full Auto Mode**.

Fixed Shutter Mode

In this mode, fixed shutter speed could be selected from the dropdown menu. The shutter speed range is from 1/10000 to 1 sec. with 19 options. Users could select suitable shutter speed according to the environmental illumination.

4.5.2 White Balance Setting

The White Balance pull-down menu is shown as follows:

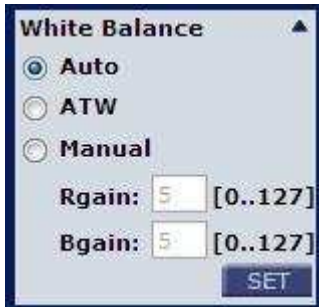

A camera needs to find reference color temperature, which is a way of measuring the quality of a light source, for calculating all the other colors. The unit for measuring this ratio is in degree Kelvin (K). Users can select one of the White Balance Control modes according to the operating environment. The following table shows the color temperature of some light sources for reference.

Light Sources	Color Temperature in K
Cloudy Sky	6,000 to 8,000
Noon Sun and Clear Sky	6,500
Household Lighting	2,500 to 3,000
75-watt Bulb	2,820
Candle Flame	1,200 to 1,500

Auto Mode

The Auto Balance White mode is suitable for environment with light source having color temperature ranging from 2700 ~ 7600K.

ATW Mode (Auto Tracking White Balance)

With Auto Tracking White Balance function, the white balance in a scene will be automatically adjusted while temperature color is changing. The ATW Mode is suitable for environment with a wider range of lighting conditions from 2500 ~ 9800K.

Manual Mode

In this mode, users can change the White Balance value manually. Users can select a number between 0 ~127 of “Rgain/ Bgain” item to gain the red/ blue illuminant on the Live Video Pane. Press <SET> to confirm the new setting.

4.5.3 Brightness Setting

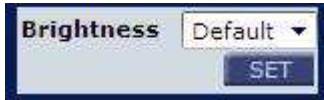

Users can adjust the image's brightness by adjusting the item. To increase video brightness, select a bigger number. Press <SET> to confirm the new setting.

4.5.4 Sharpness Setting

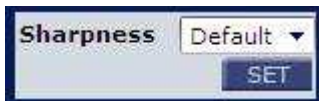

Increasing the sharpness level can make the image looked sharper; especially enhance the object's edge. Press <SET> to confirm the new setting.

4.5.5 Contrast Setting



Camera image contrast level is adjustable; please select ranging from -6 to +19. Press <SET> to confirm the new setting.

4.5.6 Saturation Setting

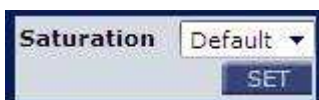

Camera image saturation level is adjustable; please select ranging from -6 to +19. Press <SET> to confirm the new setting.

4.5.7 Hue Setting



Camera image hue level is adjustable; please select ranging from -12 to +13. Press <SET> to confirm the new setting.

4.5.8 IR Function



With the IR cut filter, the Dome Camera can still catch clear image at night time or in low light conditions. Press <SET> to confirm the new setting.

4.5.9 TV System Setup

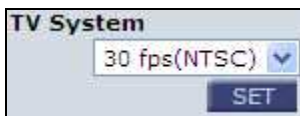

Select the video format that matches the present TV system.

4.6 Logout

Press the tab “Logout” in the top of the page, and the login window will pop up. This enables login with another user name.

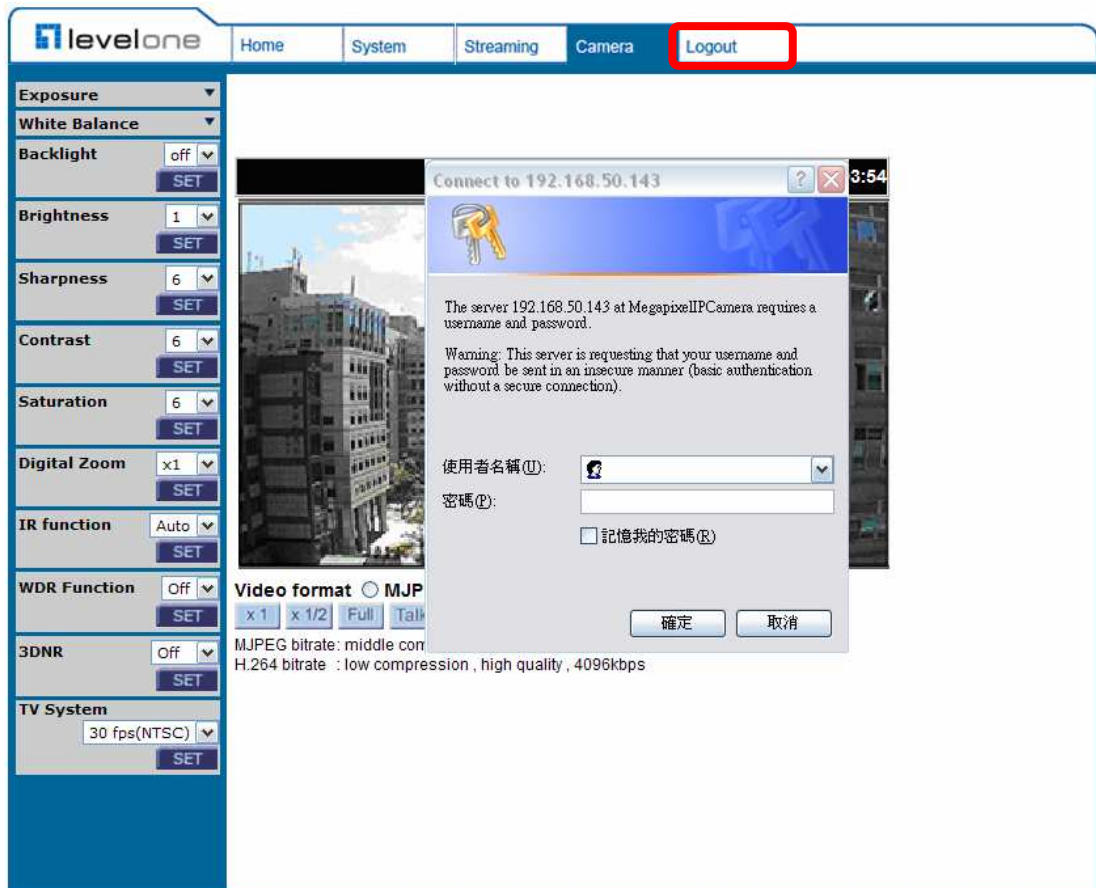

Appendix A: Technical Specifications

Camera		Full-HD
Image Sensor		1/2.5" Progressive CMOS
Picture Elements		1920(H) x 1080(V)
Minimum Illumination		0.2 lux @ F 1.2
Shutter Speed		1~ 1/10000 sec.
White Balance		Manual / ATW (1500 ~ 15000K)
Operation		
Video Compression		H.264 Main Profile / MJPEG
Video Streaming		Simultaneously H.264 + MJPEG
Resolution	H.264	Full-HD 1080p / HD 720p
	MJPEG	Full-HD 1080p / HD 720p / D1 / CIF
Frame Rate		HD 25/30 fps / Full-HD 15 fps
Image Setting	Brightness	Manual
	Exposure	Auto / Manual
	Sharpness	Manual
	Contrast	Manual
	White Balance	Auto / Manual
	Saturation	Manual
	Hue	Manual
	Digital Zoom	Zoom In / Zoom Out
	Motion detection	On / Off
	Privacy Mask	On / Off
	Privacy Mask Type	Transparent, Color
Audio	Two-way Audio	Line out, Line in/Mic in
	Compression	G.711 / G.726
Alarm	Input	5V 10kΩ pull up
	Output	Photo Relay Output 300VDC / AC
Network		
Interface		10/100Mb Ethernet (RJ-45)
Protocol		TCP/IP, UDP, RTP, RTSP, HTTP, ICMP, FTP, SMTP, DHCP, PPPoE, UPnP and IGMP
Password Levels		User and Administrator
Internet Browser		Internet Explorer (6.0+)
User Account		20
Mechanical		
Lens Mounting		Vari-Focus Board Lens
Connectors	Power	DC jack
	Ethernet	RJ-45
	Micro SD; optional	SDHC support
	Audio	Stereo phone jack, ∅ 3.5 mm
	Alarm	4 pins terminal block, pitch 3.5 mm
	Auto Iris (optional)	DC Drive

	Analog Video (optional)	1.0 Vp-p / 75Ω, BNC
LED Indicator		Power, Link, ACT
General		
Operating Temperature		0°C ~ 50°C Humidity: 10% to 90%, No Condensation
Power Source		DC 12V / PoE
Power Consumption		4W
Regulatory		CE, FCC, RoHS Compliant
Dimensions		125 x 82 x 52 mm (L x W x H) (w/o lens)
Weight		360 g (0.80 lbs)

Appendix B: Internet Security Settings

If ActiveX control installation is blocked, please either set Internet security level to default or change ActiveX controls and plug-ins settings.

Internet Security Level: Default

Step 1: Start the Internet Explorer (IE).

Step 2: Select <Tools> from the main menu of the browser. Then Click <Internet Options>.

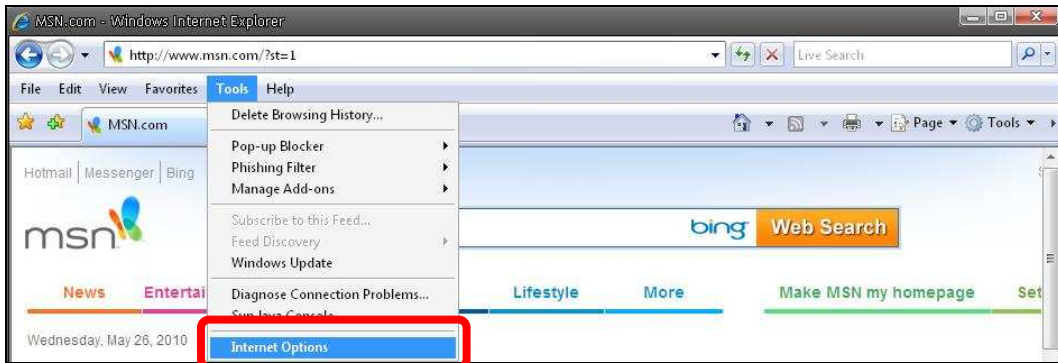

Step 3: Click the <Security> tab, and select <Internet>.



Step 4: Down the page, press “Default Level” (see the figure above) and click “OK” to confirm the setting. Close the browser window, and open a new one later when accessing the IP Camera.

ActiveX Controls and Plug-ins Settings

Step 1~3: Refer to the previous section above.

Step 4: Down the page, press “Custom Level” (see the figure below) to change ActiveX controls and plug-ins settings.



The Security Settings screen is displayed as below:

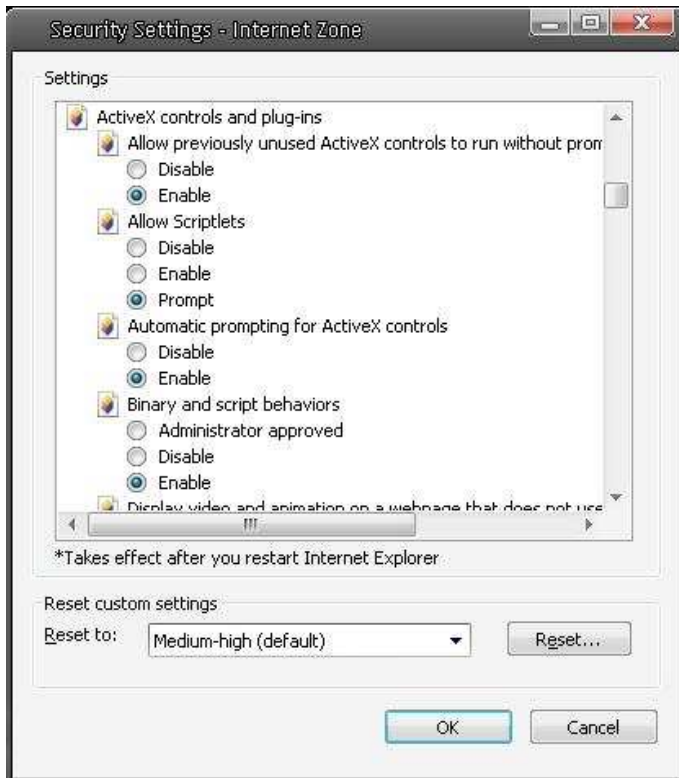

Step 5: Under “ActiveX controls and plug-ins”, set ALL items (as listed below) to <Enable> or <Prompt>.

ActiveX controls and plug-ins settings:

1. Automatic prompting for ActiveX controls
2. Binary and scrip behaviors
3. Download signed ActiveX controls
4. Download using ActiveX controls
5. Initialize and script ActiveX not marked as safe
6. Run ActiveX controls and plug-ins
7. Script ActiveX controls marked safe for scripting

Step 6: Click <OK> to accept the settings and close the <Security> screen.

Step 7: Click <OK> to close the Internet Options screen.

Step 8: Close the browser window, and restart a new one later for accessing the IP Camera.

Appendix C: DC Viewer Download Procedure

The procedure of DC Viewer software download is specified as follows.

Step 1: In the DC Viewer installation page, click “Next” for starting installing.



Step 2: Setup starts. Please wait for a while until the loading bar runs out.



Step 3: Click “Finish” to close the DC Viewer installation page.

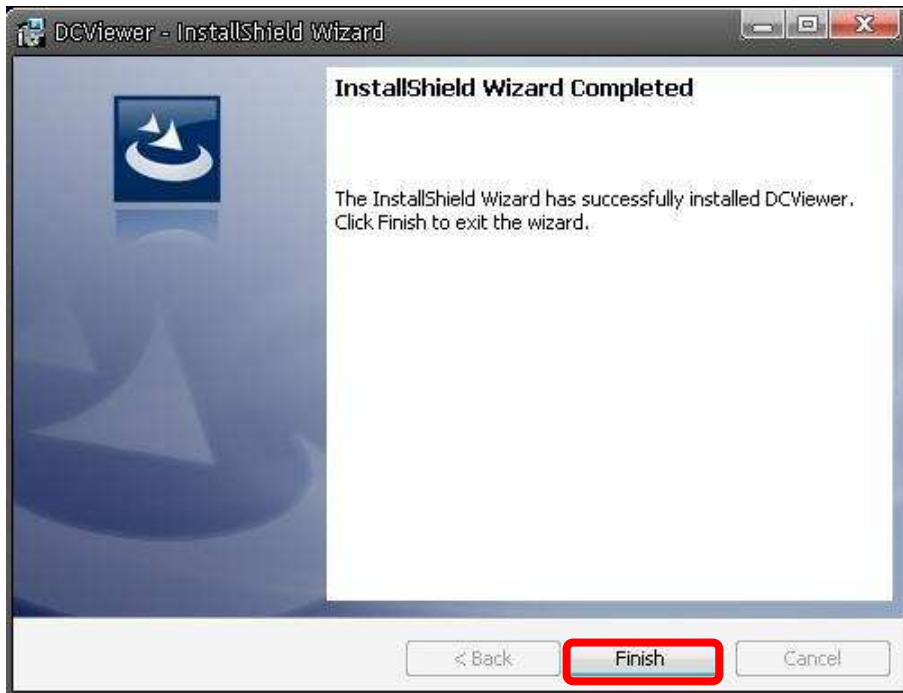

Then, the IP Camera’s Home page will display as follows:





NOTE: Please note that the function buttons will vary depending on the camera model.

Appendix D: Install UPnP Components

Please follow the instructions below to install UPnP components.

Step 1: Go to “Start”, click on “Control Panel”, and then double click “Add or Remove Programs”.

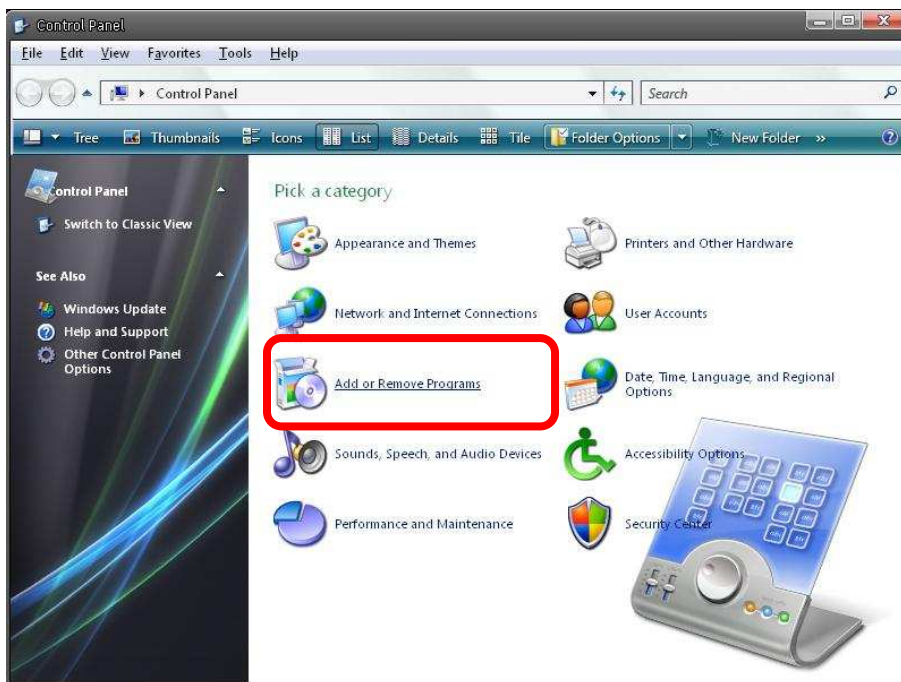

Step 2: Click on “Add/Remove Windows Components” in the Add or Remove Programs page..

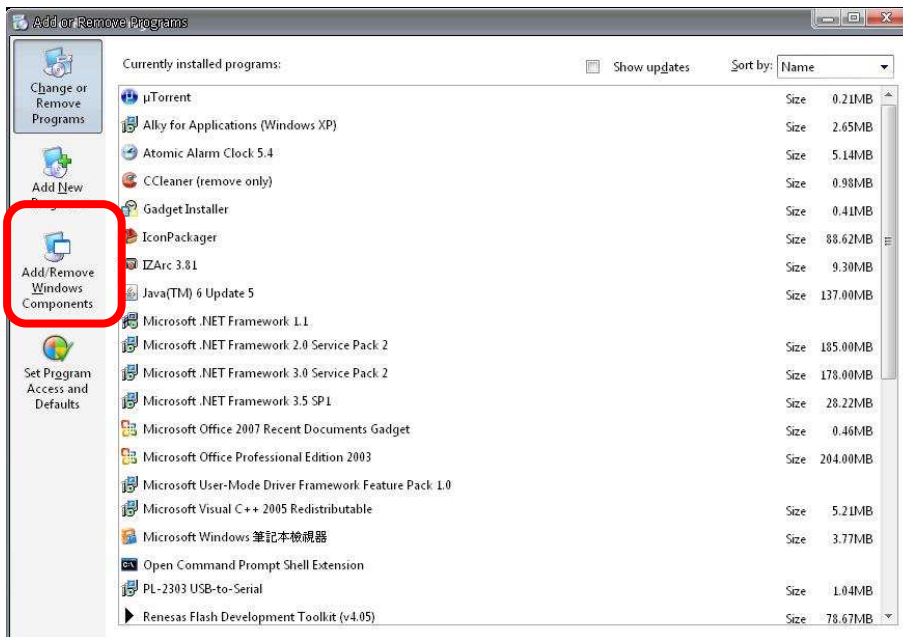

Step 3: Select “Networking Services” from the Components list in the Windows Components Wizard window, and then click “Details”.

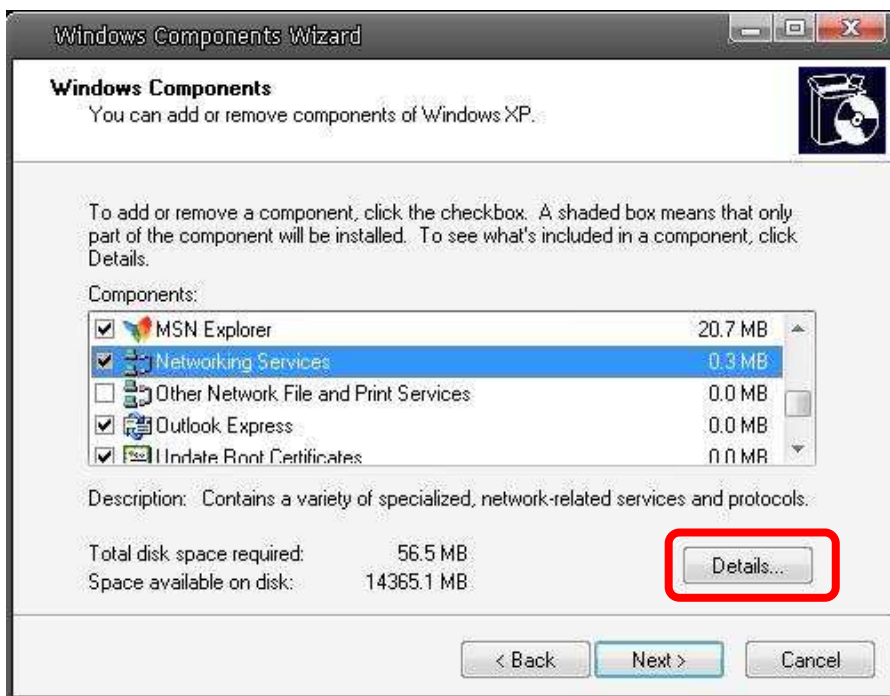

Step 4: Select “UPnP User Interface” in the Networking Services’ subcomponents list and then click “OK”.

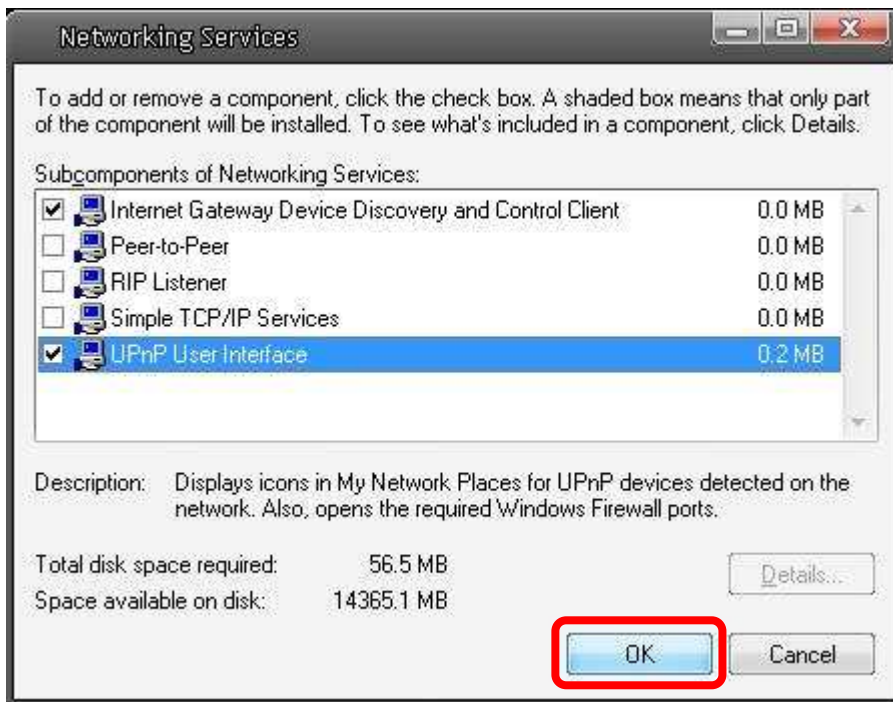

Step 5: Click “Next” in the Windows Components Wizard page.

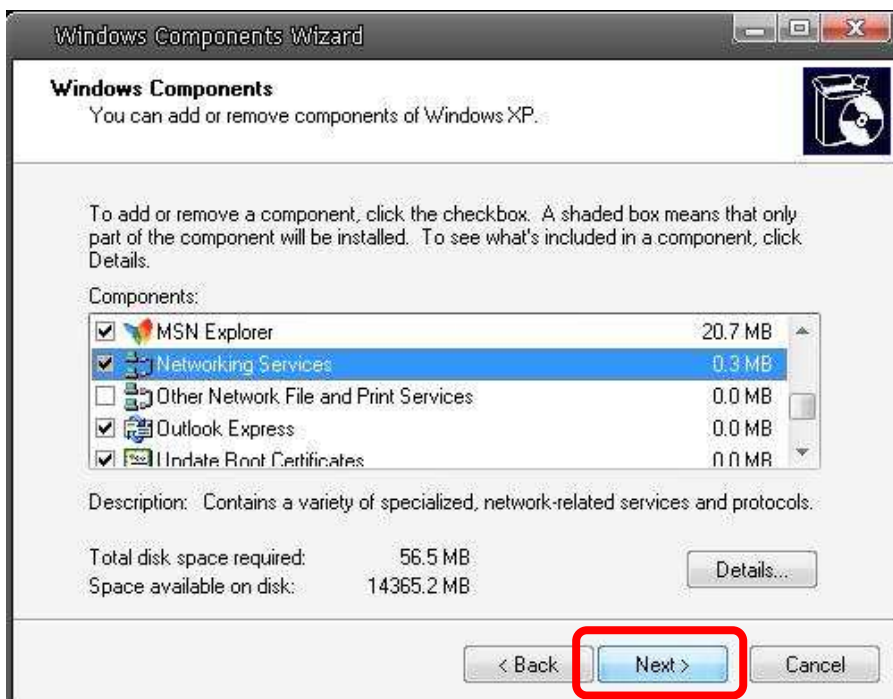

Step 6: Click “Finish” to complete installation.

