



FCS-3071

2-Megapixel PoE Dome Network Camera



User Manual

Ver1.4

# Table of Contents

<b>1. Introduction.....</b>	<b>3</b>
1.1 Features .....	3
1.2 Package Contents .....	4
1.3 Camera Overview .....	4
<b>2. Preparations for IP Camera Setup .....</b>	<b>6</b>
2.1 System Requirements .....	6
<b>3. Accessing Camera .....</b>	<b>6</b>
Using recording software.....	11
Installing DC Viewer Software Online.....	12
<b>4. Configuration &amp; Operation.....</b>	<b>15</b>
4.1 Browser-based Viewer Introduction .....	15
4.2 Home Page.....	17
4.3 System Related Settings.....	19
4.3.1 Host Name and System Time Setting.....	20
4.3.2 Security .....	21
4.3.3 Network.....	24
4.3.4 DDNS.....	29
4.3.5 Mail .....	30
4.3.6 FTP .....	31
4.3.7 Motion Detection .....	32
4.3.8 Storage Management.....	36
4.3.9 Recording.....	38
4.3.10 File Location.....	39
4.3.11 View Log File.....	40
4.3.12 View User Information .....	41
4.3.13 View Parameters .....	43
4.3.14 Factory Default.....	44
4.3.15 Software Version .....	45
4.3.16 Software Upgrade .....	46
4.3.17 Maintenance.....	49
4.4 Video Streaming Settings .....	50
4.4.1 Video Resolution and Rotate Type .....	50
4.4.2 Video Compression .....	53
4.4.3 Video OCX Protocol .....	55
4.4.4 Video Frame Skip.....	56
4.4.5 Video Mask .....	57
4.5 Camera Settings.....	58
4.5.1 Exposure Setting.....	58

4.5.2	White Balance Setting .....	60
4.5.3	Brightness Setting .....	61
4.5.4	Sharpness Setting .....	61
4.5.5	Contrast Setting .....	61
4.5.6	Saturation Setting.....	61
4.5.7	Hue Setting .....	62
4.5.8	TV System Setup .....	62
4.6	Logout .....	63
<b>Appendix A: Technical Specifications .....</b>		<b>64</b>
<b>Appendix B: Internet Security Settings .....</b>		<b>66</b>
<b>Appendix C: DC Viewer Download Procedure .....</b>		<b>69</b>
<b>Appendix D: Install UPnP Components .....</b>		<b>71</b>

**Default ID / Password**

Login ID	Password
root	null(without password)

# 1. Introduction

The LevelOne FCS-3071 is a compact, rugged H.264 2-Megapixel PoE Mini Dome Camera designed for tough environments. The casing is tamper-resistant, it can withstand vibration, humidity, dust and fluctuating temperatures found. for example buses and trains.

The FCS-3071 is a palm-sized, discreet network camera specifically designed for mass transit vehicles. The flat tamper-resistant casing makes it ideal for installation. The IP66 rating provides a rugged package for both indoor and outdoor applications

In compatible with EN50155, the standard for electronic equipment operating in railway vehicles, the FCS-3071 is an economical mobile surveillance solution with high reliability and rugged performance.







The FCS-3071 utilizes PoE (Power-over-Ethernet), allowing it to be operated and powered from a single Ethernet cable, giving greater ease of installation and cost savings. In order to facilitate on-board storage and data portability, the FCS-3071 is also complete with a Micro SD/SDHC card slot for local recording.

## 1.1 Features

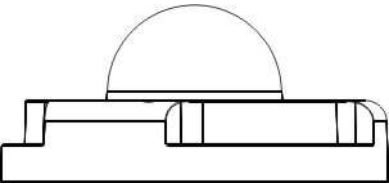
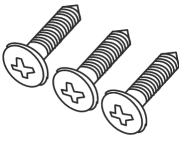
- 2-Megapixel Progressive Scan CMOS Sensor
- Dual streaming simultaneously
- H.264 and MJPEG Compression
- Shockproof for Rolling Stock Applications
- Weatherproof IP66 housing & RJ-45 dongle cable
- Micro SD/SDHC Card Slot for On-Board Storage
- Powered by PoE (802.3af) Only
- Free software included (Industry-leading 64-channel IP CamSecure™ software)

## 1.2 Package Contents

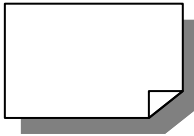
Please check the package contains the following items listed below.

 <p>Indoor Camera/ Rugged Camera (with Cable)</p>	 <p>Self-tapping screws (x3)</p>	 <p>Plastic Anchors (x3)</p>	 <p>Security Screw (x1)</p>
 <p>Rubber Washer (x1, Casing) Rubber Washers (x3, Baseplate) (Rugged Camera only)</p>	 <p>Security Torx</p>	 <p>Quick Guide</p>	 <p>CD</p>

## 1.3 Camera Overview

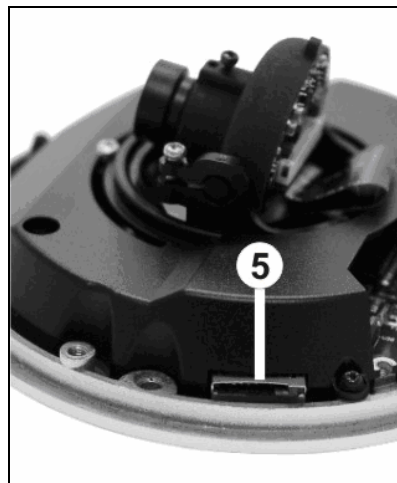
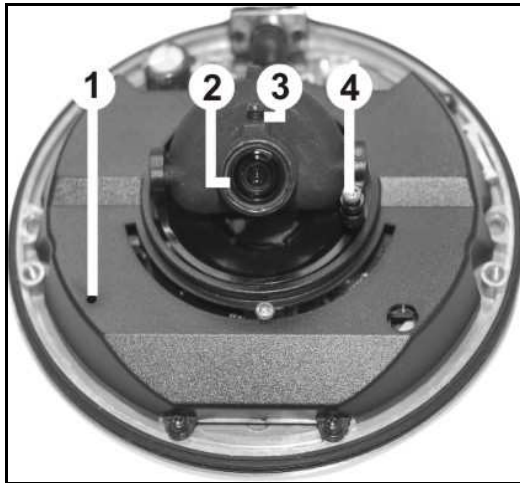

Designation		Description
1	Reset Button	Restore to default setting; press the button with a proper tool
2	Lens	Rotate the lens right/left to adjust focus
3	Focus Fixed Screw	Loosen the screw to adjust the lens
4	Tilt Fixed Screw	Loosen the screw to adjust tilt angle
5	Micro SD Card Slot	Micro SD Card recording

**Dimensions**

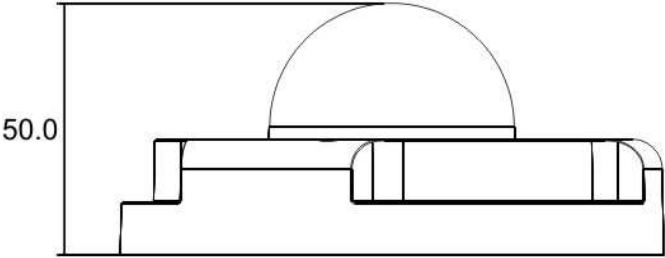
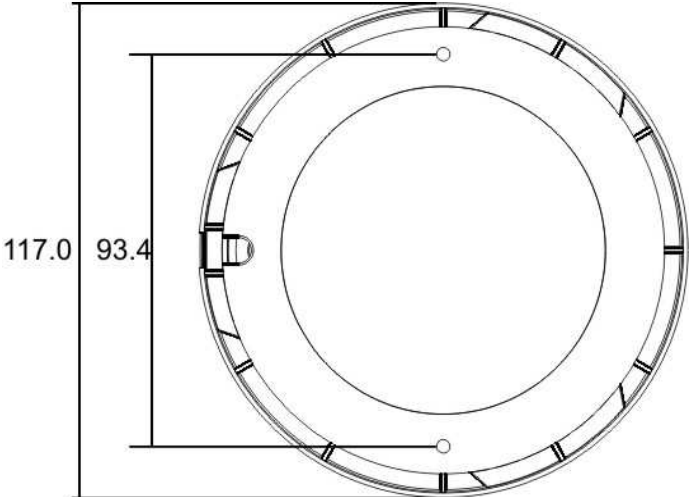

Unit: (mm)

## 2. Preparations for IP Camera Setup

This chapter provides information about system requirements for IP Dome Camera operation, power and Ethernet connection for Indoor/Outdoor IP Dome Camera and ways to access to the camera.

### 2.1 System Requirements

To perform the IP Camera via web browser, please ensure your PC is in good network connection, and meet system requirements as described below.

Items	System Requirement
<b>Personal Computer</b>	1. Intel® Pentium® M, 2.16 GHz or Intel® Core™2 Duo, 2.0 GHz 2. 2 GB RAM or more
<b>Operating System</b>	Windows VISTA or Windows XP
<b>Web Browser</b>	Microsoft Internet Explorer 6.0 or later
<b>Network Card</b>	10Base-T (10 Mbps) or 100Base-TX (100 Mbps) operation
<b>Viewer</b>	ActiveX control plug-in for Microsoft IE

## 3. Accessing Camera

For initial access to the IP Camera, users can search the camera through the installer program: DeviceSearch.exe, which can be found in “Device Search” folder in the supplied CD.

### Device Search Software Setup

**Step 1:** Double click on the program Device Search.exe (see the icon below); its window will appear as shown below. Then click the “Device Search” button.



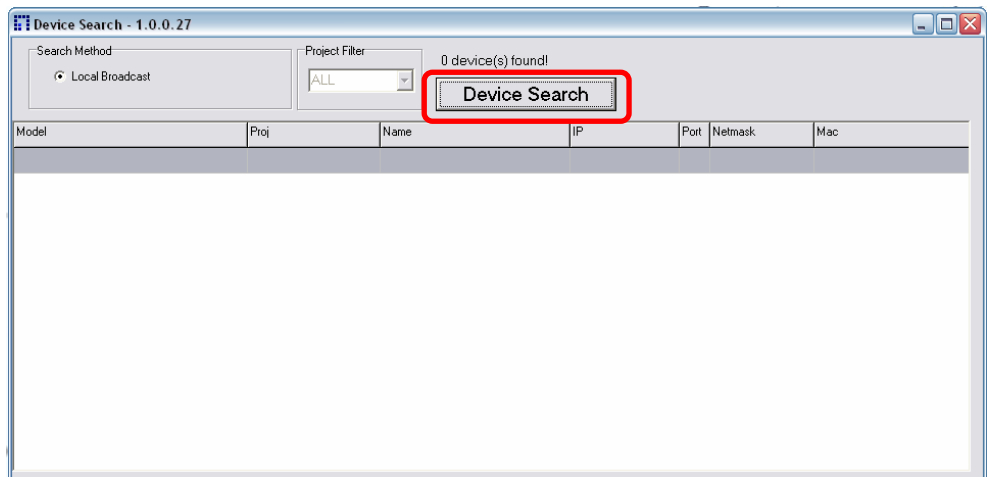

**Step 2:** The security alert window will pop up. Click “Unblock” to continue.



### Device Search

**Step 3:** Click “Device Search” again, and all the finding IP devices will be listed in the page, as shown in the figure below. The IP Camera’s default IP address is: **192.168.0.250**.

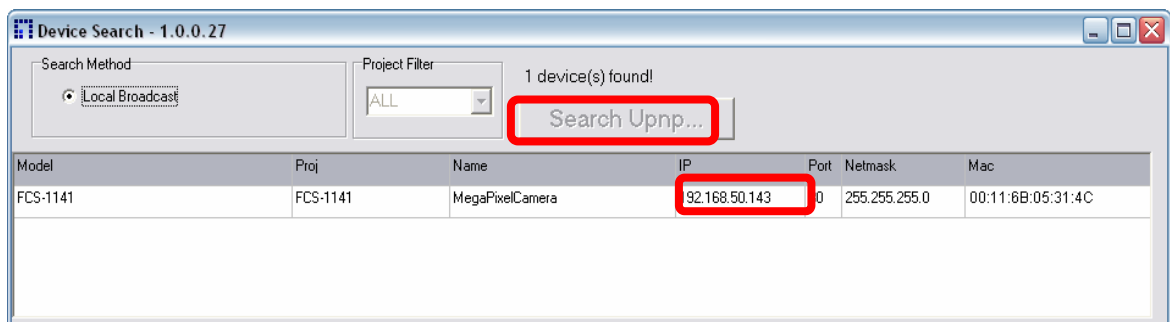

**Step 4:** Double click or right click and select “Browse” to access the camera directly via web browser.



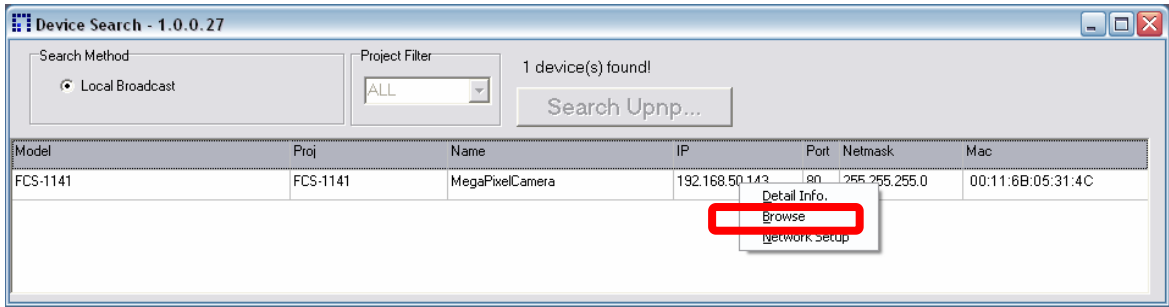

**Step 5:** Then the prompt window of request for entering default username and password (as shown below) will appear for logging in to the IP Dome Camera.



The default login ID and password are:

Login ID	Password
root	null(without password)



**NOTE:** ID and password are case sensitive.



**NOTE:** It is strongly advised that administrator's password be altered for the security concerns. Refer to section [5.3.2 Security](#) for further details.

Additionally, users can change the IP Camera's network property, either DHCP or Static IP, directly in the device finding list. Refer to the following section for changing the IP Camera's network property.

## Example of Changing IP Camera's Network Property

Users can directly change an IP Camera's network property, ex. from static IP to DHCP, in the finding device list. The way to change the IP Camera's network property is specified below:

**Step 1:** In the finding device list, click on the IP Camera that you would like to change its network property. On the selected item, right click and select "Network Setup." Meanwhile, record the IP Camera's MAC address, for future identification.

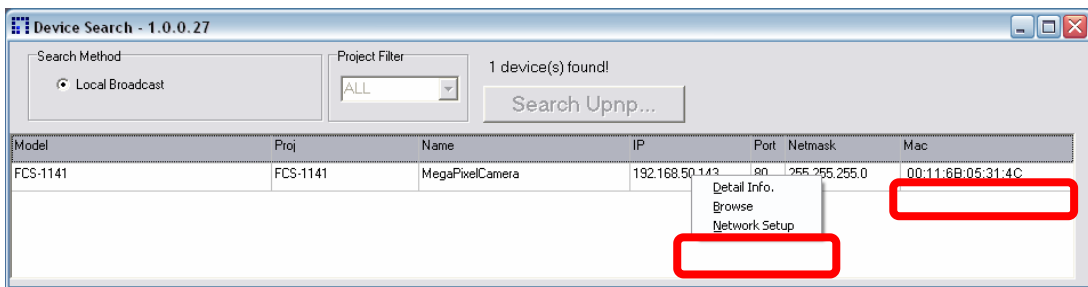

**Step 2:** The "Network Setup" page will come out. Select "DHCP," and press "Apply" button down the page.

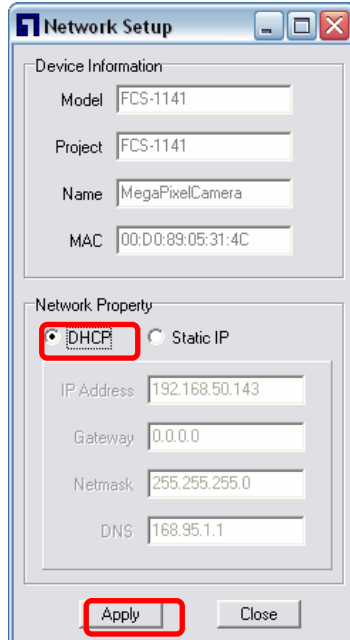

**Step 3:** Click "OK" on the Note of setting change. Wait for one minute to re-search the IP Camera.



**Step 4:** Click the “Device Search” button to search all the devices. Then select the IP Camera with the correct MAC address. Double click on the IP Camera, and the login window will come out.

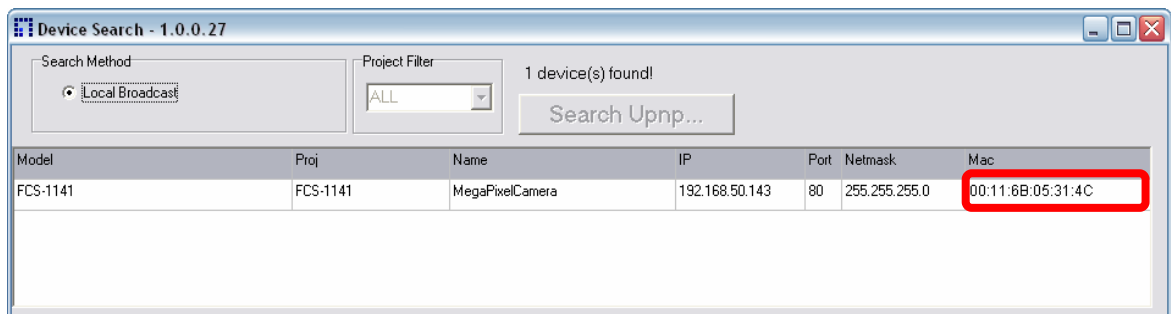

**Step 5:** Enter User name and Password to access the IP Camera.

## Using recording software

The product software CD also contains recording software-IP CamSecure, allowing simultaneous monitoring and video recording for multiple Network Cameras. Please install the recording software; then launch the program to add the Network Camera to the Channel list. For detailed information about how to use IP CamSecure, please refer to the user's manual of the software or download it at <http://global.level1.com>.



## Installing DC Viewer Software Online

For the initial access to the IP Camera, a client program, DC Viewer, will be automatically installed to your PC when connecting to the IP Camera.

If the Web browser doesn't allow DC Viewer installation, please check the Internet security settings or ActiveX controls and plug-ins settings (see [Appendix B: Internet Security Settings](#)) to continue the process.

The Information Bar (just below the URL bar) may come out and ask for permission to install the ActiveX Control for displaying video in browser (see the figure below). Right click on the Information Bar and select "Install ActiveX Control..." to allow the installation.

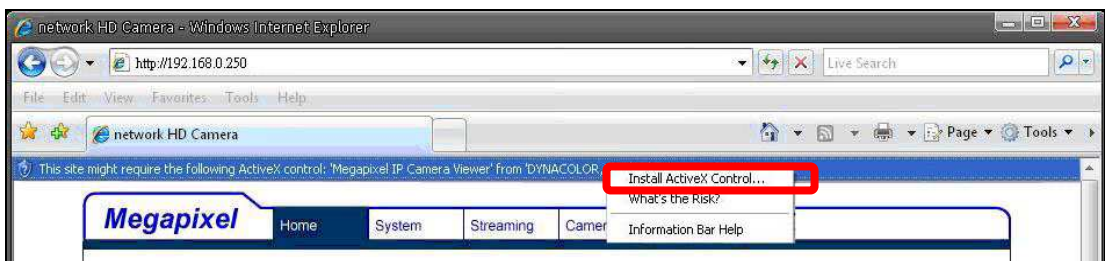

Then the security warning window will pop up. Click "Install" to carry on software installation.



Click "Finish" to close the DC Viewer window when download is finished. For the detailed software download procedure, please refer to [Appendix C: DC Viewer Download Procedure](#).

Once login to the IP Camera, users will see the Home page as shown below:

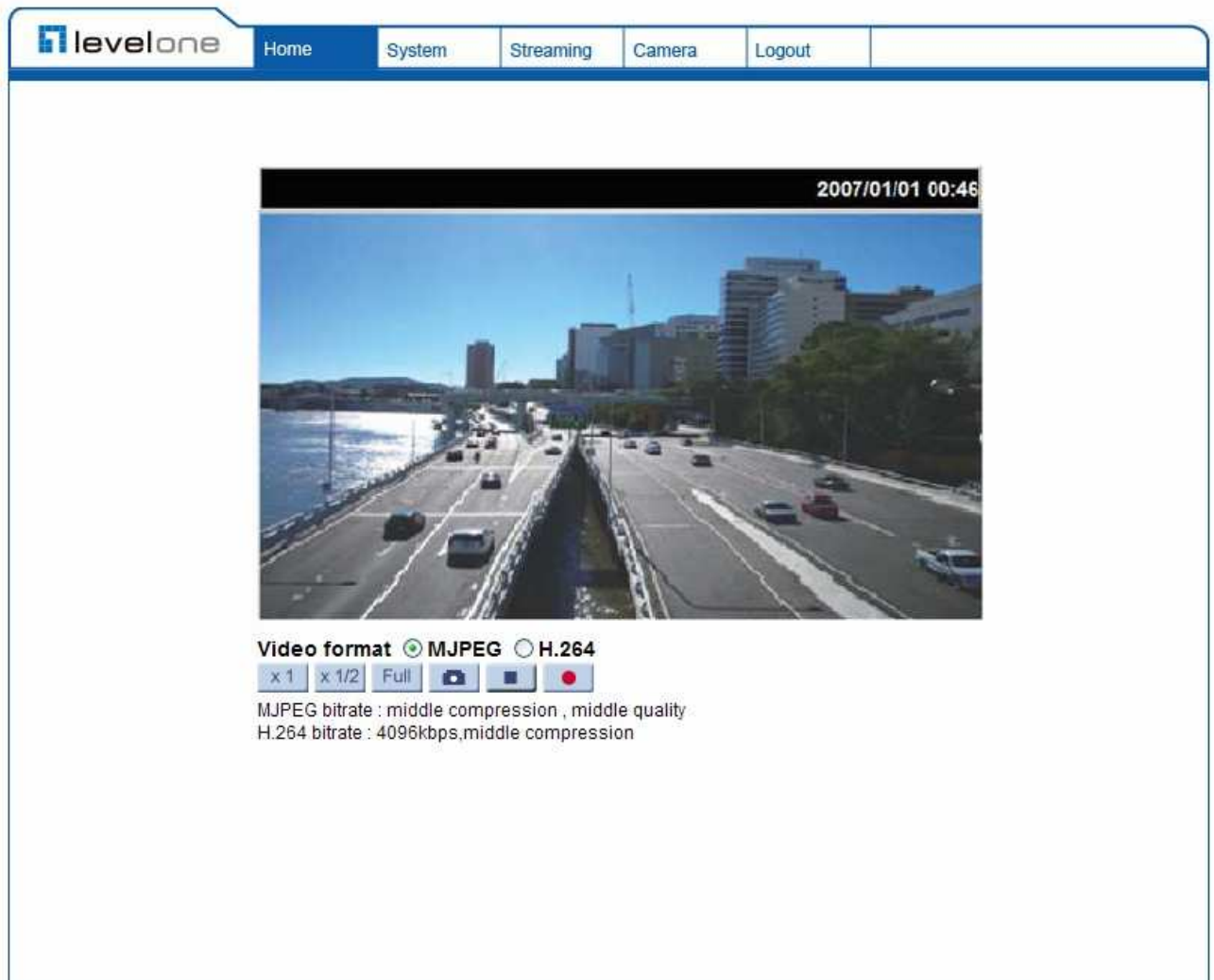

### **Administrator/User Privileges**

“Administrator” represents the person who can configure the IP Camera and authorize user’s access to the camera; “User” refers to whoever has access to the camera with limited authority, i.e. entering Home and Camera setting pages.

### **Image and Focus Adjustment**

The image displays on the Home page when successfully accessing to the IP Camera. Adjust zoom and focus as necessary to produce a clear image.

**Step 1:** Unscrew the IP Dome Camera’s cover.



**Step 2:** Loosen the focus fixed screw, and rotate the lens counter-/clockwise to adjust focus; loosen the tilt fixed screw, and adjust the camera's tilt angle.

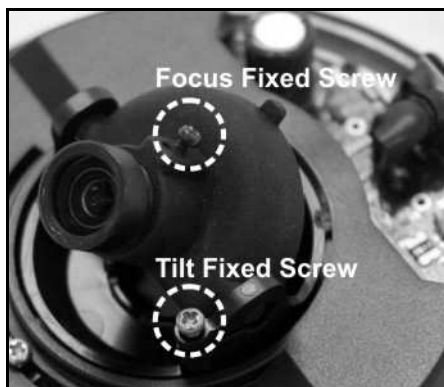

## 4. Configuration & Operation

The IP Camera is provided with a user-friendly browser-based configuration interface, as well as a free bundled CMS (Central Management System) for video playback and recording. In this chapter, information about main page introduction, system related settings and camera settings will be described in detail.

For further information about CMS software, please refer to IP CamSecure user manual.

### 4.1 Browser-based Viewer Introduction

The figure below shows the Home page of the IP Camera's Viewer Window.

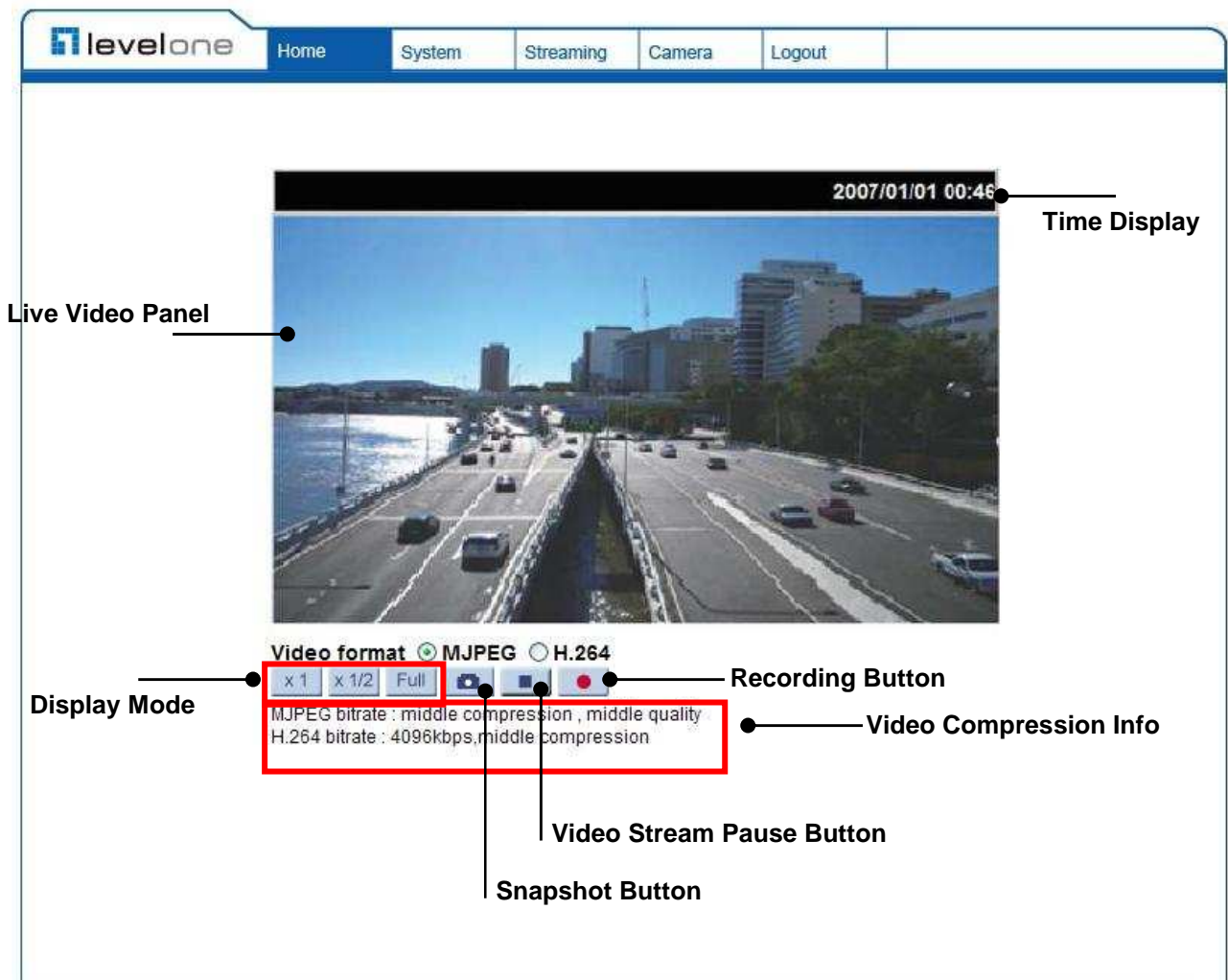

**NOTE:** Please note that the function buttons will vary depending on the camera model.



There are five tabs: Home, System, Streaming, Camera and Logout on the top of the viewer window.

### **Home**

Users can monitor live video of the targeted area.

### **System setting**

The administrator can set host name, system time, root password, network related settings, etc. Further details will be interpreted in section [“System Related Settings”](#).

### **Streaming setting**

The administrator can modify video resolution and rotate type in this page.

### **Camera setting**

Users can adjust various camera parameters, including <Exposure>, <White Balance>, <Brightness>, <Sharpness>, <Contrast> and <Digital Zoom>.

### **Logout**

Click on the tab to re-login the IP Camera with another username and password.

## 4.2 Home Page

In the Home page, there are several function buttons right down the displayed image.

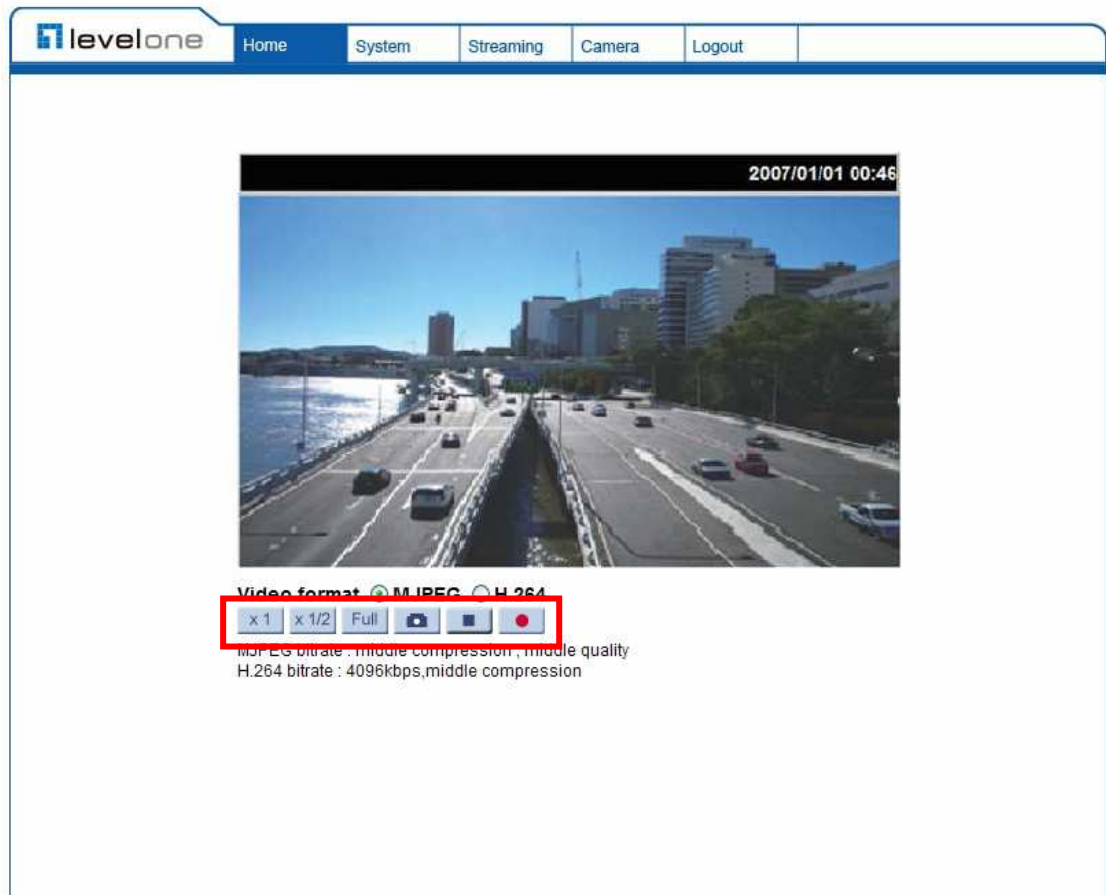

**NOTE:** Please note that the function buttons will vary depending on the camera model.

### Screen Size Adjustment

Image display size can be adjusted to x1/2 and full screen.



### Digital Zoom Control

In the full screen mode, users can implement digital PTZ by rotating the mouse wheel (for zoom in/out), and drag the mouse into any direction.

### Snapshot button



Press the button, and the JPEG snapshots will automatically be saved in the appointed place. The default place of saving snapshots is: C:\. To change the storage location, please refer to section "[File Location](#)" for further details.

**Video Streaming Pause /Restart button**   (pause/restart)

Press the stop button to disable video streaming, the live video will be displayed as black. Press the restart button to show the live video again.

**Recording button**   (on/off)

Press the button and the recordings from the Live View will be saved to the location specified in the “File Location” (snapshot) page; see section “[File Location](#)” for further details.

## 4.3 System Related Settings

The figure below shows all categories under the “**System**” tab. Each category in the left column will be explained in the following sections.



**NOTE:** The “System” configuration page is only accessible by the Administrator.

**System**

Host Name : MegaPixelCamera

Time zone : GMT+08:00 China, Hong Kong, Australia Western, Singapore, Taiwan, Russia

Enable daylight saving time

time offset: 01:00:00

Start date: Jan 1st Sun Start time: 00:00:00

End date: Jan 1st Sun End time: 00:00:00

Sync with computer time

PC date: 2010/12/09 [yyyy/mm/dd]

PC time: 14:28:50 [hh:mm:ss]

Manual

Date: 2007/01/01 [yyyy/mm/dd]

Time: 00:00:00 [hh:mm:ss]

Sync with NTP server

NTP server: time-a.nist.gov [host name or IP address]

Update interval: Every hour

Save

## 4.3.1 Host Name and System Time Setting

Press the first category: <System> in the left column; the page is shown as below.

The screenshot shows the 'levelone' web interface. The top navigation bar includes 'Home', 'System', 'Streaming', 'Camera', and 'Logout'. On the left, a vertical menu lists various system categories, with 'System' highlighted in red. The main content area is titled 'System' and contains the following settings:

- Host Name :** MegaPixelCamera
- Time zone :** GMT+08:00 China, Hong Kong, Australia Western, Singapore, Taiwan, Russia
- Enable daylight saving time**
  - time offset: 01:00:00
  - Start date: Jan 1st Sun Start time: 00:00:00
  - End date: Jan 1st Sun End time: 00:00:00
- Sync with computer time**
  - PC date: 2010/12/09 [yyyy/mm/dd]
  - PC time: 14:28:50 [hh:mm:ss]
- Manual**
  - Date: 2007/01/01 [yyyy/mm/dd]
  - Time: 00:00:00 [hh:mm:ss]
- Sync with NTP server**
  - NTP server: time-a.nist.gov [host name or IP address]
  - Update interval: Every hour
  -

### Host Name

The name is for camera identification. If alarm function is enabled and is set to send alarm message by Mail/FTP, the host name entered here will display in the alarm message.

### Time Zone

Select the time zone you are in from the drop-down menu.

### Enable Daylight Saving Time

To enable DST, please check the item and then specify time offset and DST duration. The format for time offset is [hh:mm:ss]; for instance, if the amount of time offset is one hour, please enter "01:00:00" into the field.

### Sync With Computer Time

Select the item, and video date and time display will synchronize with the PC's.

## Manual

The Administrator can set video date, time and day manually. Entry format should be identical with that shown next to the enter fields.

## Sync with NTP server

Network Time Protocol (NTP) is an alternate way to synchronize your camera's clock with a NTP server. Please specify the server you wish to synchronize in the enter field. Then select an update interval from the drop-down menu. For further information about NTP, please see the web site: [www.ntp.org](http://www.ntp.org).

## 4.3.2 Security

Click the category: <Security>, and the page is shown as the figure below.

The screenshot displays the LevelOne web interface. The top navigation bar includes 'Home', 'System', 'Streaming', 'Camera', and 'Logout'. The left sidebar contains a menu with 'Security' highlighted in red. The main content area is titled 'Security' and contains the following sections:

- root Password:** Two text input fields for 'root password' and 'Confirm password', both containing dots. A 'Save' button is to the right.
- Add User:** Two text input fields for 'User name' and 'User password'. Below them are four checkboxes: 'I/O access' (checked), 'Camera control', 'Talk', and 'Listen'. An 'Add' button is to the right.
- Manage User:** A dropdown menu for 'User name' showing 'tt', with 'Delete' and 'Edit' buttons to its right.

## Root password

Change the administrator's password by inputting the new password in both text boxes. The input characters/numbers will be displayed as dots for security purposes. After clicking <Save>, the web browser will ask the Administrator for the new password for access. The maximum length of the password is 14 digits.



**NOTE:** The following characters are valid: A-Z, a-z, 0-9, !#\$%&'-.@^\_~.

### **Add user**

Type the new user's name and password and click <Add> to add the new user. Both user name and password can be up to 16 characters. The new user will be displayed in the user name list. There is a maximum of twenty user accounts. Each user can be assigned the privileges of “**Camera control**” and/or “**Listen**”.

- **I/O access**

This item supports fundamental functions that enable users to view video when accessing to the camera.

- **Camera control**

This item allows the appointed User to change camera parameters on the Camera Setting page.

- **Talk/Listen**

Talk and Listen functions allow the appointed user in the local site (PC site) communicating with, for instance, the administrator in the remote site.



**NOTE:** The Compact IP Dome Camera does not have the Talk function.

### **Manage User**

#### **Delete user**

To delete a user, pull down the user list, and select the user name you wish to delete. Then click <Delete> to remove it.

#### **Edit user**

Pull down the user list and select a user name. Click <Edit> to edit the user's password and privilege.



**NOTE:** It is required to enter the User password as well as select the function open to the user. When finished, click <Save> to modify the account authority.





### 4.3.3 Network

Click <Network> in the left column, and the page will display as shown below.

The screenshot shows the 'levelone' web interface. The left sidebar contains a menu with items: System, Security, Network (highlighted with a red box), DDNS, Mail, FTP, Motion detection, Storage management, Recording, File location, View log file, View user information, View parameters, Factory default, Software version, Software upgrade, and Maintenance. The main content area is titled 'Network' and is divided into three sections: 'General', 'Advanced', and 'UPnP Setting'. In the 'General' section, the 'Use fixed IP address' radio button is selected. The 'Advanced' section has three input fields for ports. The 'UPnP Setting' section has two checkboxes and one input field for a friendly name.

Users can choose to connect to the IP Camera with fixed or dynamic (DHCP) IP address. The IP Camera also provides PPPoE support for users who connect to the network via PPP over Ethernet (PPPoE).

#### **Get IP address automatically (DHCP)**

The camera's default setting is "Use fixed IP address". Please refer to the previous section "[Accessing Camera](#)" for logging in with the default IP address.

If select "Get IP address automatically", after the IP Camera restarts, users can search it through the installer program: Device Search.exe, which can be found in "Device Search" folder in the supplied CD.



**NOTE:** Please make the record of the IP Camera's MAC address, which can be found in the label of the camera, for identification in the future.

## Use fixed IP address

To setup static IP address, select “**Use fixed IP address**” and move the cursor to the IP address blank (as indicated below) and insert the new IP address, ex. 192.168.7.123; then go to the Default gateway (explained latter) blank and change the setting, ex. 192.168.7.254. Press “Save” to confirm the new setting.

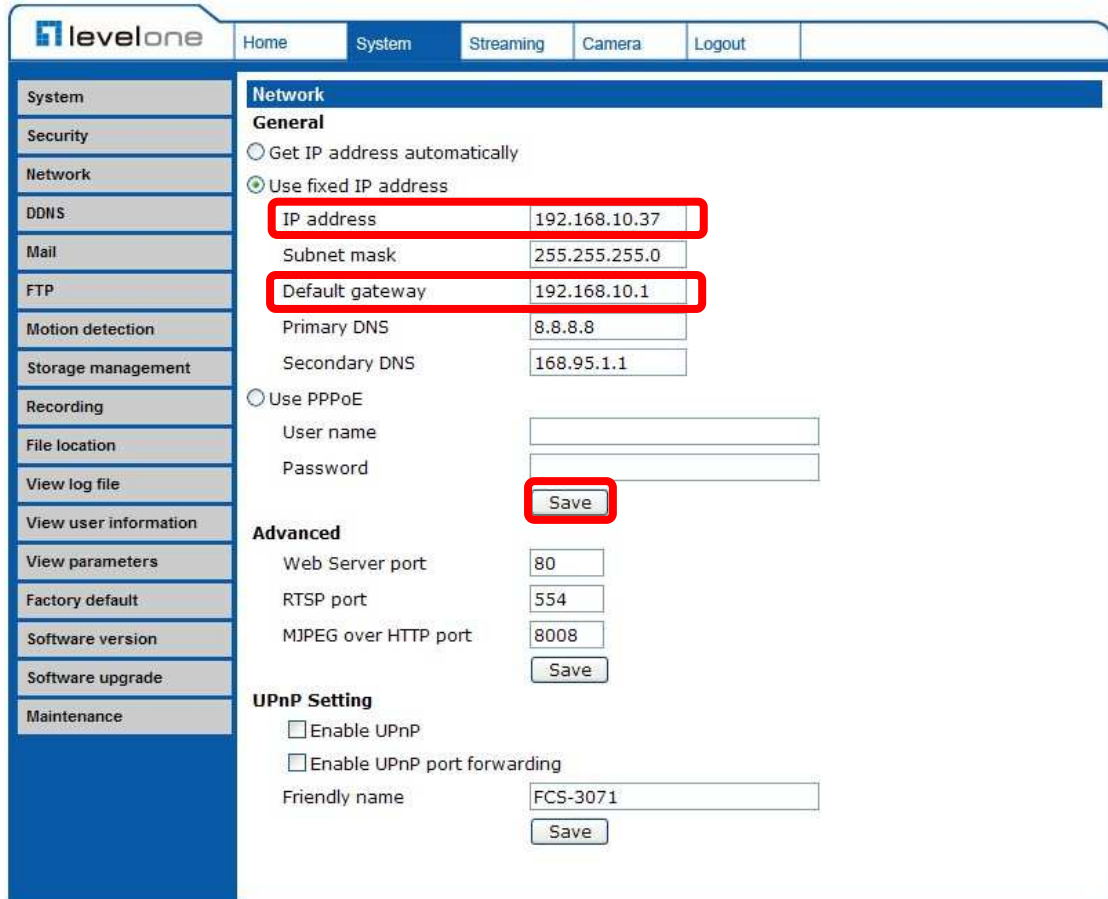

The screenshot shows the 'levelone' web interface with the 'System' tab selected. The 'Network' section is active, and the 'General' sub-section is expanded. The 'Use fixed IP address' option is selected. The 'IP address' field is set to '192.168.10.37', the 'Subnet mask' is '255.255.255.0', and the 'Default gateway' is '192.168.10.1'. The 'Primary DNS' is '8.8.8.8' and the 'Secondary DNS' is '168.95.1.1'. The 'Use PPPoE' option is unselected, and the 'Save' button is highlighted. The 'Advanced' section shows 'Web Server port' as '80', 'RTSP port' as '554', and 'MJPEG over HTTP port' as '8008'. The 'UPnP Setting' section shows 'Enable UPnP' and 'Enable UPnP port forwarding' unselected, and 'Friendly name' as 'FCS-3071'.

When using static IP address to login to the IP Camera, users can access it either through “Device Search” software (see [:Accessing Camera](#)) or input the IP address in the URL bar and press “Enter”.

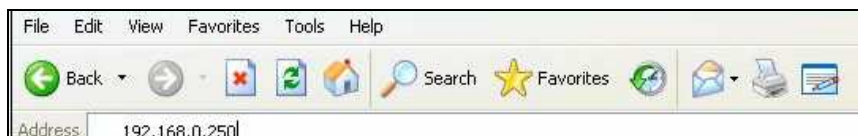

- **IP address**  
This is necessary for network identification.
- **Subnet mask**  
It is used to determine if the destination is in the same subnet. The default value is “255.255.255.0”

- **Default gateway**  
This is the gateway used to forward frames to destinations in different subnet. Invalid gateway setting will fail the transmission to destinations in different subnet.
- **Primary DNS**  
Primary DNS is the primary domain name server that translates hostnames into IP addresses.
- **Secondary DNS**  
Secondary DNS is a secondary domain name server that backups the primary DNS.

### Use PPPoE

For the PPPoE users, enter the PPPoE Username and Password into the fields, and click on the “Save” button to complete the setting.

### Advanced

- **Web Server port**  
The default web server port is 80. Once the port is changed, the user must be notified the change for the connection to be successful. For instance, when the Administrator changes the HTTP port of the IP Camera whose IP address is 192.168.0.100 from 80 to 8080, the user must type in the web browser “http://192.168.0.100:8080” instead of http://192.168.0.100.
- **RTSP port**  
RTSP port could be set from 1 to 65535. (Normal Setting Port: 554, 1024 ~65535)
- **MJPEG over HTTP port**  
The default setting of HTTP Port is 8008; setting range: 1024 ~65535.



**NOTE:** Be aware to choose the different port from the one set for the web server port.

## UPnP Setting

- **Enable UPnP**

When the UPnP is enable, whenever the IP Camera is presented to the LAN, the icon of the connected IP Cameras will appear in My Network Places to allow for direct access as shown below.

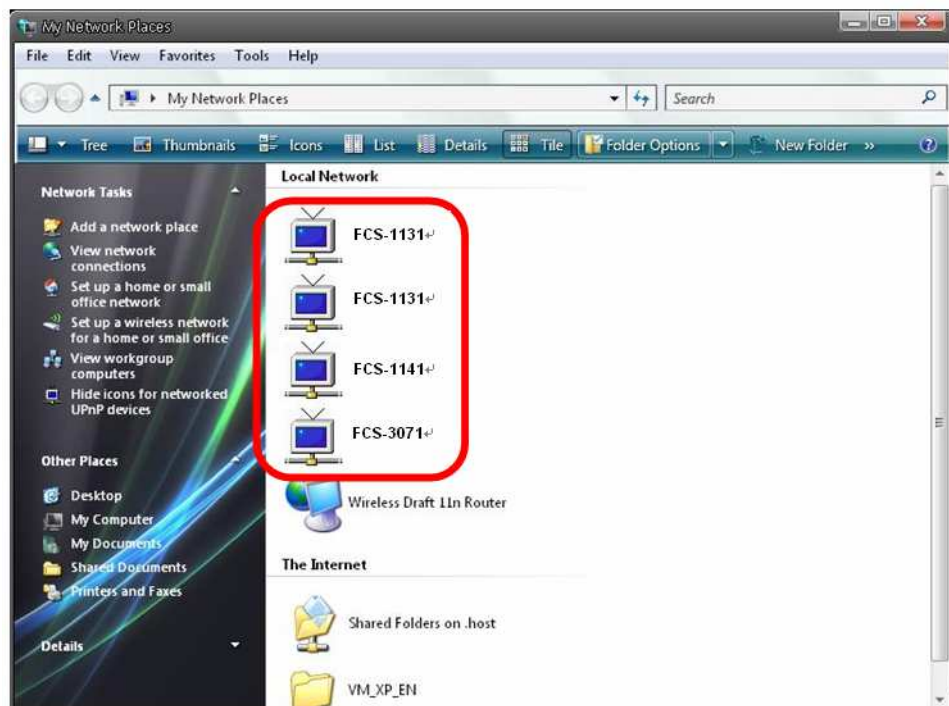
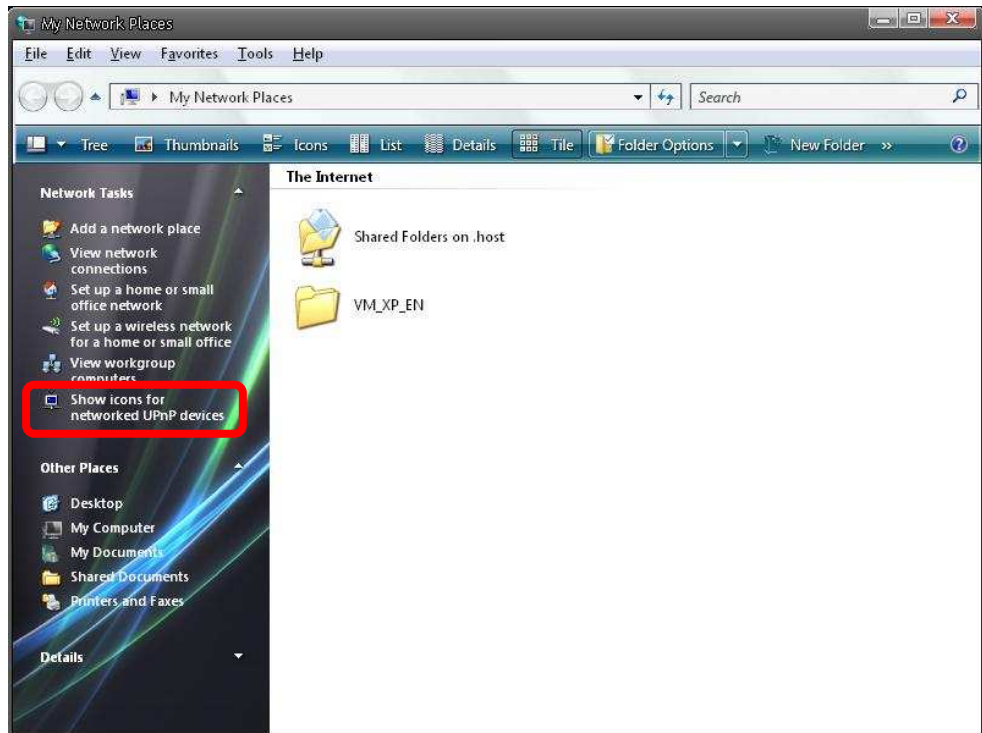



**NOTE:** To enable this function, please make sure the UPnP component is installed on your computer. Please refer to [Appendix D: Install UPnP components](#) for UPnP component installation procedure.

- **Enable UPnP port forwarding**

When the UPnP port forwarding is enabled, the IP Camera is allowed to open the web server port on the router automatically.



**NOTE:** To enable this function, please make sure that your router supports UPnP and it is activated

- **Friendly name**

Set the name for the IP Camera for identity.

## 4.3.4 DDNS

Dynamic Domain Name System (DDNS) allows a host name to be constantly synchronized with a dynamic IP address. In other words, it allows those using a dynamic IP address to be associated to a static domain name so others can connect to it by name.

The screenshot displays the 'levelone' web interface. The top navigation bar includes 'Home', 'System', 'Streaming', 'Camera', and 'Logout'. The left sidebar contains a menu with items: System, Security, Network, DDNS (highlighted with a red box), Mail, FTP, Motion detection, Storage management, Recording, File location, View log file, View user information, View parameters, Factory default, Software version, Software upgrade, and Maintenance. The main content area is titled 'DDNS' and contains the following configuration options:

- Dynamic DNS**  
Use Dynamic DNS If You Want To Use Your DDNS Account.
- Enable DDNS
- Provider: DynDNS.org(Dynamic) (dropdown menu)
- Host name: [input field]
- Username/E-mail: [input field]
- Password/Key: [input field]
- Save (button)

### Enable DDNS

Check the item to enable DDNS.

### Provider

Select one DDNS host from the provider list.

### Host name

Enter the registered domain name in the field.

### Username/E-mail

Enter the username or e-mail required by the DDNS provider for authentication.

## Password/Key

Enter the password or key required by the DDNS provider for authentication.

### 4.3.5 Mail

The Administrator can send an e-mail via Simple Mail Transfer Protocol (SMTP) when motion is detected. SMTP is a protocol for sending e-mail messages between servers. SMTP is a relatively simple, text-based protocol, where one or more recipients of a message are specified and the message text is transferred. The configuration page is shown as follows:

The screenshot displays the LevelOne web interface. The top navigation bar includes 'Home', 'System', 'Streaming', 'Camera', and 'Logout'. The left sidebar contains a list of system settings: System, Security, Network, DDNS, Mail (highlighted with a red box), FTP, Motion detection, Storage management, Recording, File location, View log file, View user information, View parameters, Factory default, Software version, Software upgrade, and Maintenance. The main content area is titled 'Mail' and contains the following configuration fields:

SMTP	
1st SMTP (mail) server	<input type="text"/>
1st SMTP (mail) server port	<input type="text"/>
1st SMTP account name	<input type="text"/>
1st SMTP password	<input type="text"/>
1st recipient email address	<input type="text"/>
2nd SMTP (mail) server	<input type="text"/>
2nd SMTP (mail) server port	<input type="text"/>
2nd SMTP account name	<input type="text"/>
2nd SMTP password	<input type="text"/>
2nd recipient email address	<input type="text"/>
Sender email address	<input type="text"/>

Save

Two sets of SMTP can be configured. Each set includes SMTP Server, Account Name, Password and E-mail Address settings. For SMTP server, contact your network service provider for more specific information.

## 4.3.6 FTP

The Administrator can set as sending alarm message to a specific File Transfer Protocol (FTP) site when motion is detected. Users can assign alarm message to up to two FTP sites. The FTP setting page is shown below. Enter the FTP details, which include server, server port, user name, password and remote folder, in the fields. Press “Save” when finished.

**levelone** Home System Streaming Camera Logout

**FTP**

**1st FTP**

Built-in FTP server port: 21

1st FTP server: [text box]

1st FTP server port: 21

1st FTP user name: [text box]

1st FTP password: [text box]

1st FTP remote folder: [text box]

1st FTP passive mode

**2nd FTP**

2nd FTP server: [text box]

2nd FTP server port: 21

2nd FTP user name: [text box]

2nd FTP password: [text box]

2nd FTP remote folder: [text box]

2nd FTP passive mode

Save



## 4.3.7 Motion Detection

Motion Detection function allows detecting suspicious motion and triggering alarms when motion volume in the detected area reaches/exceeds the determined sensitivity threshold value.

The screenshot displays the LevelOne web interface for Motion Detection settings. The left sidebar has a menu with 'Motion detection' highlighted. The main panel is titled 'Motion Detection' and includes a toggle switch (currently 'Off'), a 'Motion Detection Setting' section with input fields for 'Sampling pixel interval [1-10]' (value: 1), 'Detection level [1-100]' (value: 2), 'Sensitivity level [1-100]' (value: 90), and 'Time interval(sec) [0-7200]' (value: 10). Below this is the 'Triggered Action' section with checkboxes for 'Record stream to sd card', 'Send alarm message by FTP', and 'Upload image by FTP'. On the right, there is a 'Motion Detection Windows' section with an 'add' and 'delete' button, and options for 'Send alarm message by E-mail' and 'Upload image by E-Mail'. The 'Upload image by E-Mail' section includes fields for 'E-Mail address' (set to 'E-Mail 2'), 'Pre-trigger buffer' (set to '1frame'), and 'Post-trigger buffer' (set to '1frame'). There are also options for 'Continue image upload' and 'Upload for 1 sec'. At the bottom, there is a 'File Name' field set to 'testimage.jpg' and radio buttons for 'Add date/time suffix', 'Add sequence number suffix (no maximum value)', 'Add sequence number suffix up to 0 and then start over', and 'Overwrite'. A 'save' button is located at the bottom left of the settings area.

In the Motion Detection setting page, there is a frame (**Motion Detection Window**) displayed on the Live View Pane. The Motion Detection Window is for defining the motion detection area. To change the size of the Motion Detection Window, move the mouse cursor to the edge of the frame and draw it outward/inward. Moving the mouse to the center of the frame can shift the frame to the intended location.

Up to 10 Motion Detection Windows can be set. Press the “add” button under the Live View Pane to add a Motion Detection Window. To cancel a Motion Detection Window, move the mouse cursor to the selected Window, and click on the “delete” button.

If Motion Detection function is activated, the pop-off window (Motion) with indication of motion will be shown.



When motion is detected, the signals will be displayed on the Motion window as shown below.

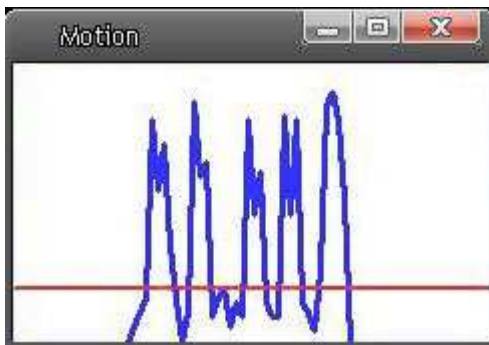

Detailed settings of Motion Detection are described as follows:

### **Motion Detection**

You will be able to turn on/off Motion Detection in System section. Default setting is Off.

### **Motion Detection Setting**

Users could adjust various parameters of Motion Detection in this section.

- Sampling pixel interval [1-100]:  
The default value is 10, which means system will take one sampling pixel for every 10 pixel.
- Detection level [1-100]:  
The default level is 10. The item is to set detection level for each sampling pixel; the smaller the value, the more sensitive it is.

- **Sensitivity level [1-100]:**  
The default level is 80, which means if 20% or more sampling pixels are detected differently, system will detect motion. The bigger the value, the more sensitive it is. Meanwhile, when the value is bigger, the red horizontal line in the motion indication window will be lower accordingly.
- **Time interval (sec) [0-7200]:**  
The default interval is 10. The value is the interval between each detected motion.

### **Triggered Action (Multi-option)**

The Administrator can specify alarm actions that will take when motion is detected. All options are listed as follows:

- **Enable Alarm Output**  
Check the item and select the predefined type of alarm output to enable alarm relay output when motion is detected.



**NOTE:** This option is excluded in the Compact IP Dome Camera.

- **Record stream to SD Card**  
Select this item, and the Motion Detection recording will be stored in Micro SD/ SDHC card when motion is detected.



**NOTE:** Please make sure the local recording (with Micro SD/ SDHC card) is activated so that this function can be implemented. See section "[Recording](#)" for further details.

- **Send Alarm Message by FTP/E-Mail**  
The Administrator can select whether to send an alarm message by FTP and/or E-Mail when motion is detected.
- **Upload Image by FTP**  
Select this item, and the Administrator can assign a FTP site and configure various parameters as shown in the figure below. When motion is detected, event images will be uploaded to the appointed FTP site.

Upload Image by FTP

FTP address FTP1 ▾

Pre-trigger buffer 5 frames ▾

Post-trigger buffer 5 frames ▾

Continue image upload

Upload for  sec

Upload during the trigger active

Image frequency Max. ▾ fps

- **Upload Image by E-Mail**

Select this item, and the Administrator can assign an e-mail address and configure various parameters as shown in the figure below. When motion is detected, event images will be sent to the appointed e-mail address.

Upload Image by E-Mail

E-Mail address E-Mail 1 ▾

Pre-trigger buffer 5 frames ▾

Post-trigger buffer 5 frames ▾

Continue image upload

Upload for  sec

Upload during the trigger active

Image frequency Max. ▾ fps



**NOTE:** Make sure SMTP or FTP configuration has been completed. See section “[Mail](#)” and “[FTP](#)” for further details.

### **File Name**

The uploaded image’s filename format can be set in this section. Please select the one that meets your requirements.

### **Save**

Click the Save button to save all the Motion Detection settings mentioned above.

## 4.3.8 Storage Management

Users can implement local recording to the Micro SD/SDHC card.



**NOTE:** Please format the Micro SD/SDHC card first before recording starts.

The screenshot displays the iLevelOne web interface. The left sidebar contains a menu with the following items: System, Security, Network, DDNS, Mail, FTP, Motion detection, **Storage management** (highlighted with a red box), Recording, File location, View log file, View user information, View parameters, Factory default, Software version, Software upgrade, and Maintenance. The main content area is titled 'Storage Management' and is divided into several sections:

- Device information:** Shows 'Device type: SD card', 'Free space: 0 KB', 'Status: No', 'Total size: 0 KB', and 'Full: No'.
- Device setting:** Includes a 'Format device:' label and a 'Format' button.
- Disk cleanup setting:** Features a checked checkbox for 'Enable automatic disk cleanup', a 'Remove recordings older than:' field with a value of '1' and a 'day(s)' dropdown, and a 'Remove oldest recordings when disk is:' field with a value of '50' and a '% full' label. A 'Save' button is located below these fields.
- Recording list:** Contains a table with columns 'FileName' and 'Size'. Below the table are 'Remove', 'Sort', and 'download' buttons.

### Device information

When users insert the Micro SD/SDHC card, the card information such as the memory capacity and status will be shown at Device Information section.

### Device setting

Press the “Format” button to format the memory card.

### Disk cleanup setting

Users can enable automatic recordings cleanup by specifying the time and storage limits

## Recording List

Each video file on the Micro SD/SDHC card will be listed in the Recording list as shown below.

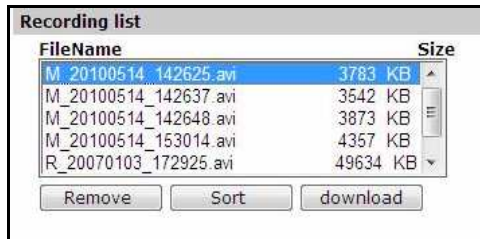

FileName	Size
M_20100514_142625.avi	3783 KB
M_20100514_142637.avi	3542 KB
M_20100514_142648.avi	3873 KB
M_20100514_153014.avi	4357 KB
R_20070103_172925.avi	49634 KB

Remove   Sort   download

- **Remove**

To remove a file, select the file first, and then press the “Remove” button.

- **Sort:**

Press the “Sort” button, and the files in the Recording list will be listed in name and date order.



**NOTE:** The capital letter A/M/R appears in the very beginning of name denotes the sort of the recording: A stands for Alarm; M stands for Motion; R stands for regular recording.

- **Download:**

To open/download a video clip, select the file first, and then press the “download” button below the Recording list field. The selected file window will pop up as shown below. Click on the AVI file to directly play the video in the player or download it to a specified location.



## 4.3.9 Recording

In the Recording setting page, users can specify the recording schedule that fits the present surveillance requirement.

The screenshot displays the 'levelone' web interface. The top navigation bar includes 'Home', 'System', 'Streaming', 'Camera', and 'Logout'. The left sidebar lists various system settings, with 'Recording' highlighted in red. The main content area is titled 'Recording' and contains the 'Recording Schedule' section. It features three radio button options: 'Disable' (selected), 'Always', and 'Only during time frame'. Under the 'Only during time frame' option, checkboxes for all days of the week (Sun, Mon, Tue, Wed, Thu, Fri, Sat) are checked. Below these, the 'Start time' is set to '00:00' and the 'Duration' is set to '24:00'. A 'Save' button is located at the bottom of the settings area.

### **Activating Micro SD/SDHC Card Recording**

Two types of schedule mode are offered: Always and Time Frame setting. Users can setup the time frame to fit the recording schedule or choose “Always” to activate Micro SD/SDHC Card Recording all the time.

Please click on the “Save” button for confirming the schedule mode.

### **Terminating Micro SD/SDHC Card Recording**

Select “Disable” to terminate the recording function.

## 4.3.10 File Location

Users can specify a storage location for the snapshots and live video recording. The default setting is: C:\. Once confirm the setting, press “Save,” and all the snapshots and recording will be saved in the designate location.



**NOTE:** Please make sure the selected file path contains valid characters such as letters and numbers.

The screenshot displays the 'levelone' web interface. At the top, there is a navigation bar with tabs for 'Home', 'System', 'Streaming', 'Camera', and 'Logout'. On the left side, a vertical menu lists various system settings: System, Security, Network, DDNS, Mail, FTP, Motion detection, Storage management, Recording, File location (highlighted with a red box), View log file, View user information, View parameters, Factory default, Software version, Software upgrade, and Maintenance. The main content area is titled 'File Location' and contains the instruction 'Set the destination of snapshot photos and recorded video files'. Below this, there is a label 'All files stored at:' followed by a text input field containing 'C:\' and a 'Select' button. A 'Save' button is positioned below the input field.



### 4.3.11 View Log File

Click on the link to view the system log file. The content of the file provides useful information about configuration and connections after system boot-up.

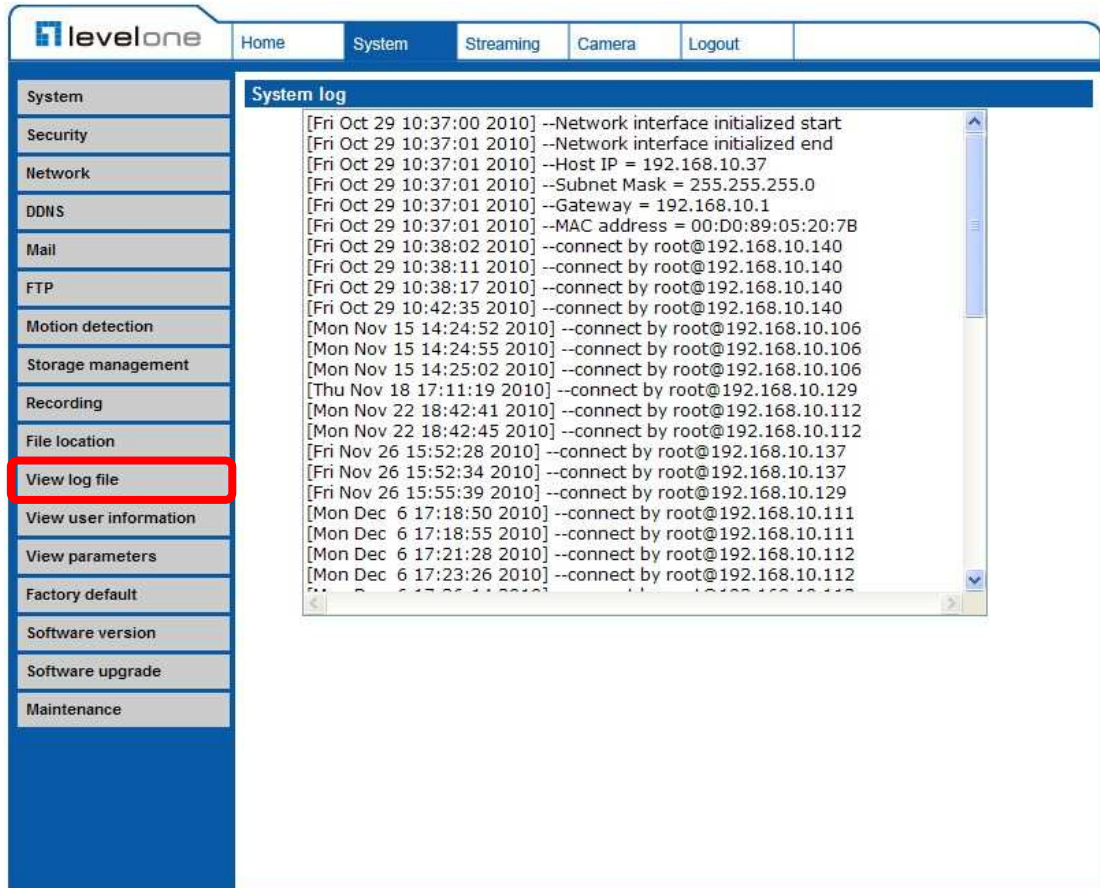

## 4.3.12 View User Information

The Administrator can view each added user's login information and privileges (see "[Security](#)").

### View User Login Information

All the users in the network will be listed in the "User information" zone, as shown below. As the figure below shows:

**User: root**

It indicates that one user's login username is: root, and the password is: blank.

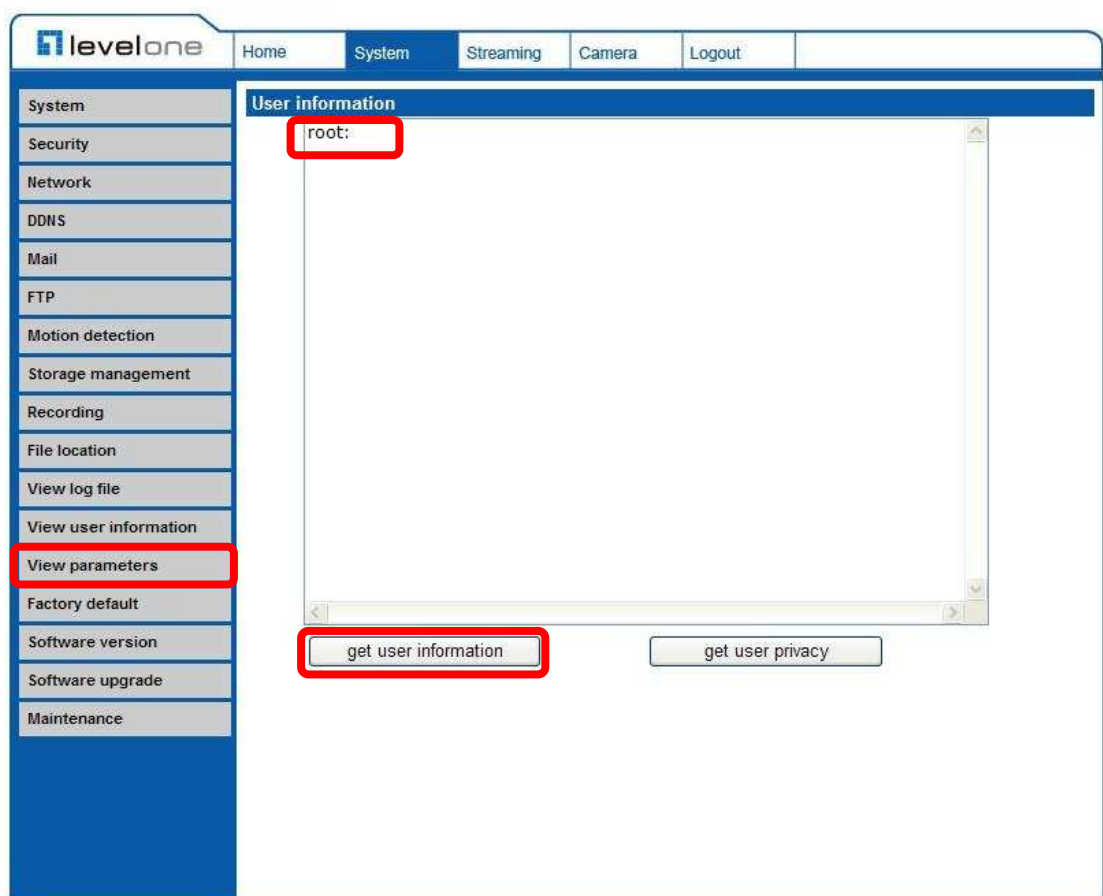

## View User Privilege

Press “get user privacy” down the page, and the Administrator can view each user’s privileges.

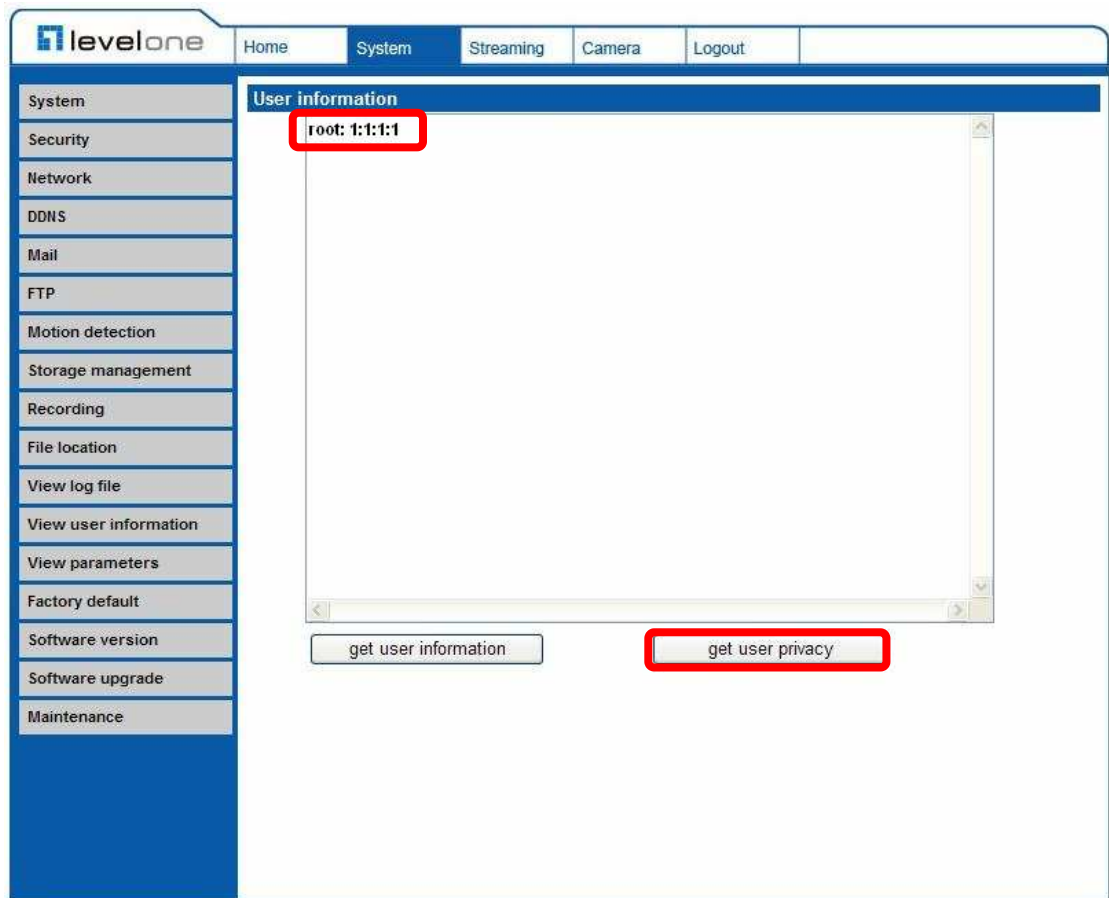

As the figure above shows:

**User: 1:1:0:1**

1:1:0:1= I/O access : Camera control : Talk : Listen (see [“Security”](#))

<input checked="" type="checkbox"/> I/O access	<input checked="" type="checkbox"/> Camera control
<input type="checkbox"/> Talk	<input checked="" type="checkbox"/> Listen

Therefore, it denotes the user is granted privileges of I/O access, Camera control and Listen.

### 4.3.13 View Parameters

Click on this item to view the entire system's parameter setting.

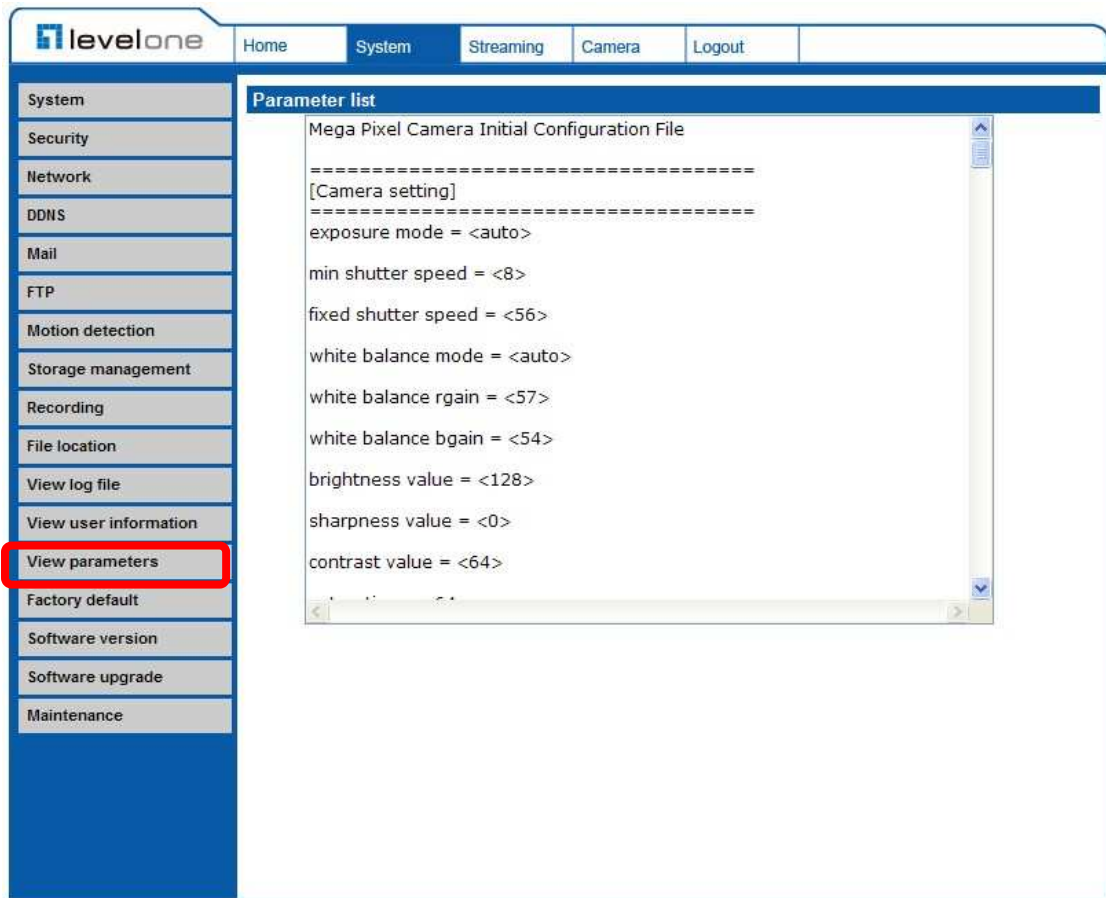

## 4.3.14 Factory Default

The factory default setting page is shown as below. Follow the instructions to reset the IP Camera to factory default setting if needed.

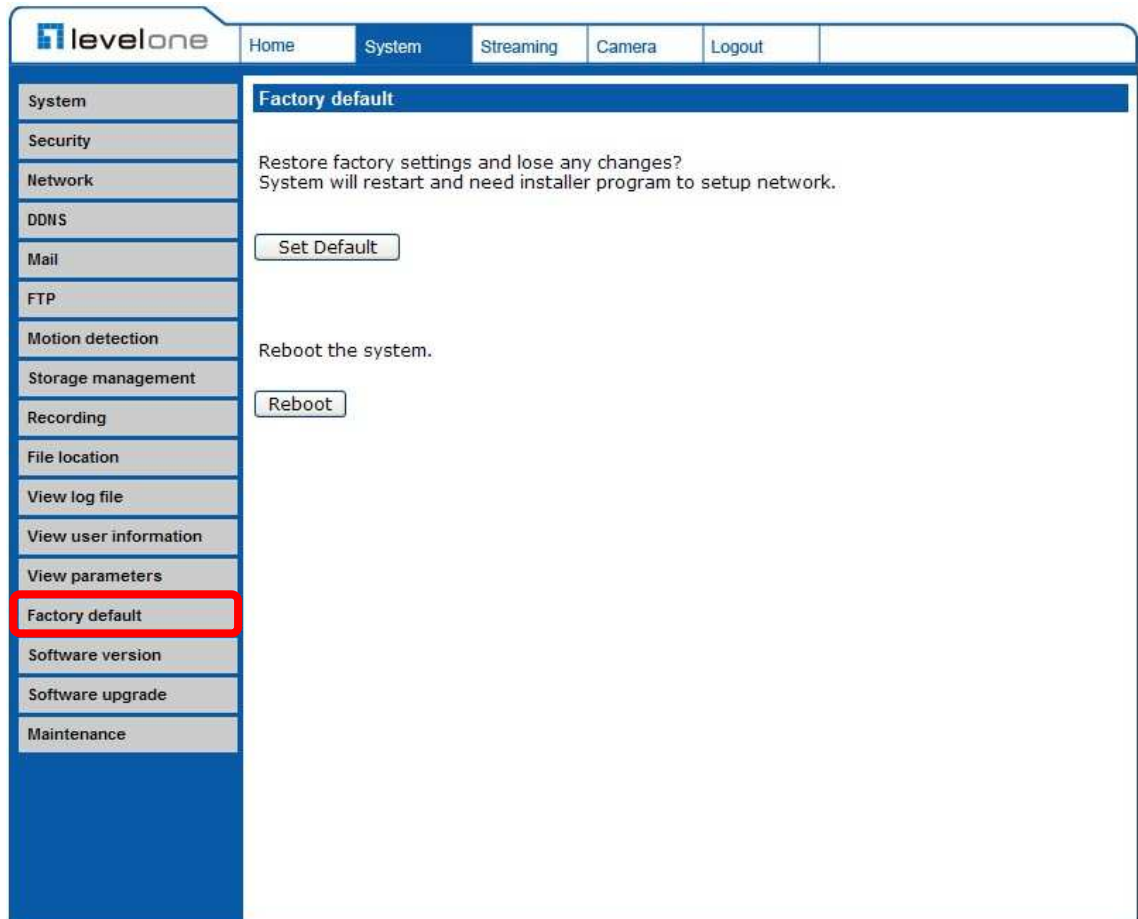

### Set Default

Click on the "Set Default" button to recall the factory default settings. Then the system will restart in 30 seconds.



**NOTE:** The IP address will be restored to default.

### Reboot

Click on the "Reboot" button, and the system will restart without changing current settings.

### 4.3.15 Software Version

The current software version is displayed in the software version page, which is shown as the figure below.

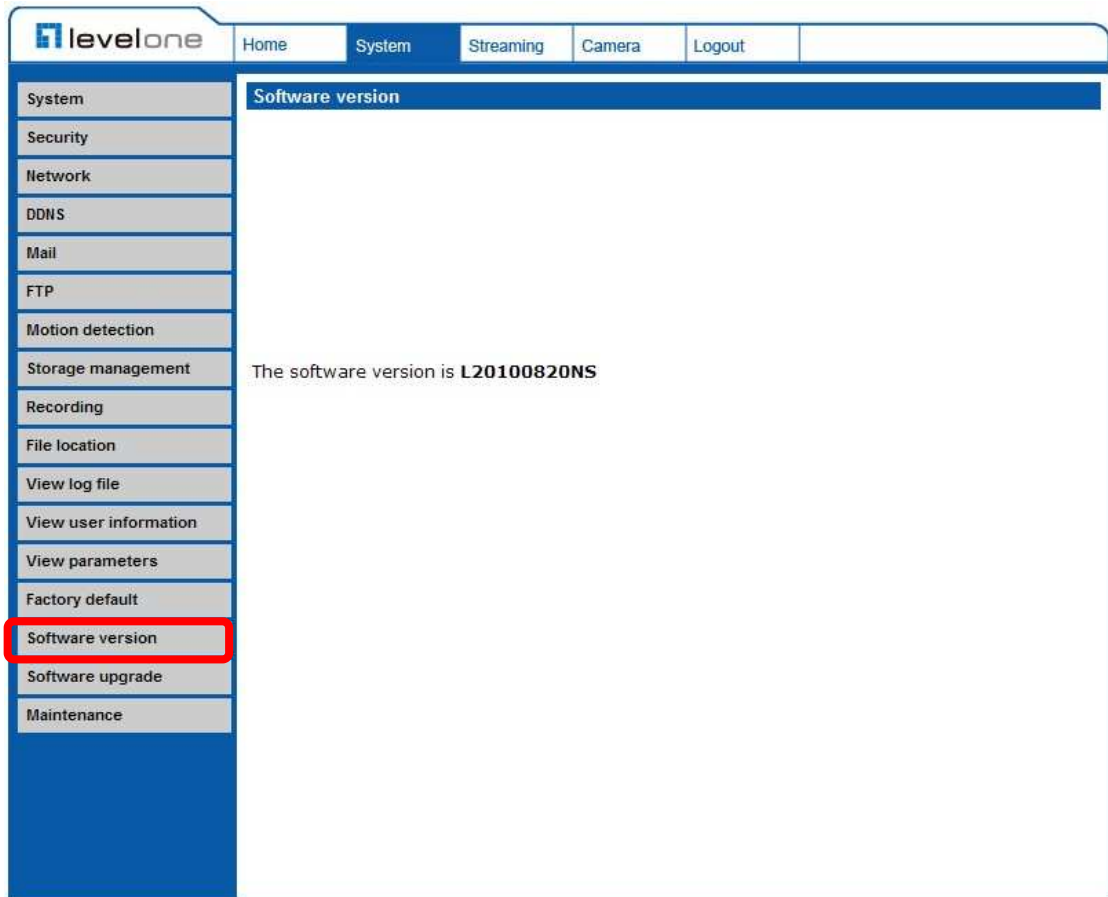

## 4.3.16 Software Upgrade

Software upgrade can be carried out in the “Software Upgrade” page, as shown below.

The screenshot shows the LevelOne web interface. The top navigation bar includes 'Home', 'System', 'Streaming', 'Camera', and 'Logout'. The left sidebar contains a list of menu items: System, Security, Network, DDNS, Mail, FTP, Motion detection, Storage management, Recording, File location, View log file, View user information, View parameters, Factory default, Software version, Software upgrade (highlighted with a red box), and Maintenance. The main content area is titled 'Upgrade' and contains the following instructions:

**Follow These Steps To Do The Software Upgrade**

**Step1:**  
Upload the binary file

**Step2:**  
Select binary file you want to upgrade

**Step3:**  
Click the upgrade button to start the upgrade process



**NOTE:** Make sure the upgrade software file is available before carrying out software upgrade.

The procedure of software upgrade is like the following:

**Step 1:** Click “Browse” and select the binary file to be uploaded, ex. Userland.jffs2.

The screenshot shows the LevelOne web interface. The navigation menu on the left includes System, Security, Network, DDNS, Mail, FTP, Motion detection, Storage management, Recording, File location, View log file, View user information, View parameters, Factory default, Software version, Software upgrade, and Maintenance. The main content area is titled "Upgrade" and contains the following steps:

- Step1:** Upload the binary file. The file path is "C:\LevelOne\Firmware\userland.jffs2" and the "Browse..." button is highlighted with a red box.
- Step2:** Select binary file you want to upgrade. The dropdown menu shows "userland.jffs2".
- Step3:** Click the upgrade button to start the upgrade process. The "Upgrade" button is visible.



**NOTE:** Do not change the upgrade file name, or the system will fail to find the file.

**Step 2:** Pull down the upgrade binary file list and select the file you want to upgrade; in this case, select “userland.jffs2.”

**Step 3:** Press “Upgrade”. The system will first check whether the upgrade file exists or not, and then begin to upload the upgrade file. Subsequently, the upgrade status bar will display on the page. When it runs to 100%, the upgrade process is finished.



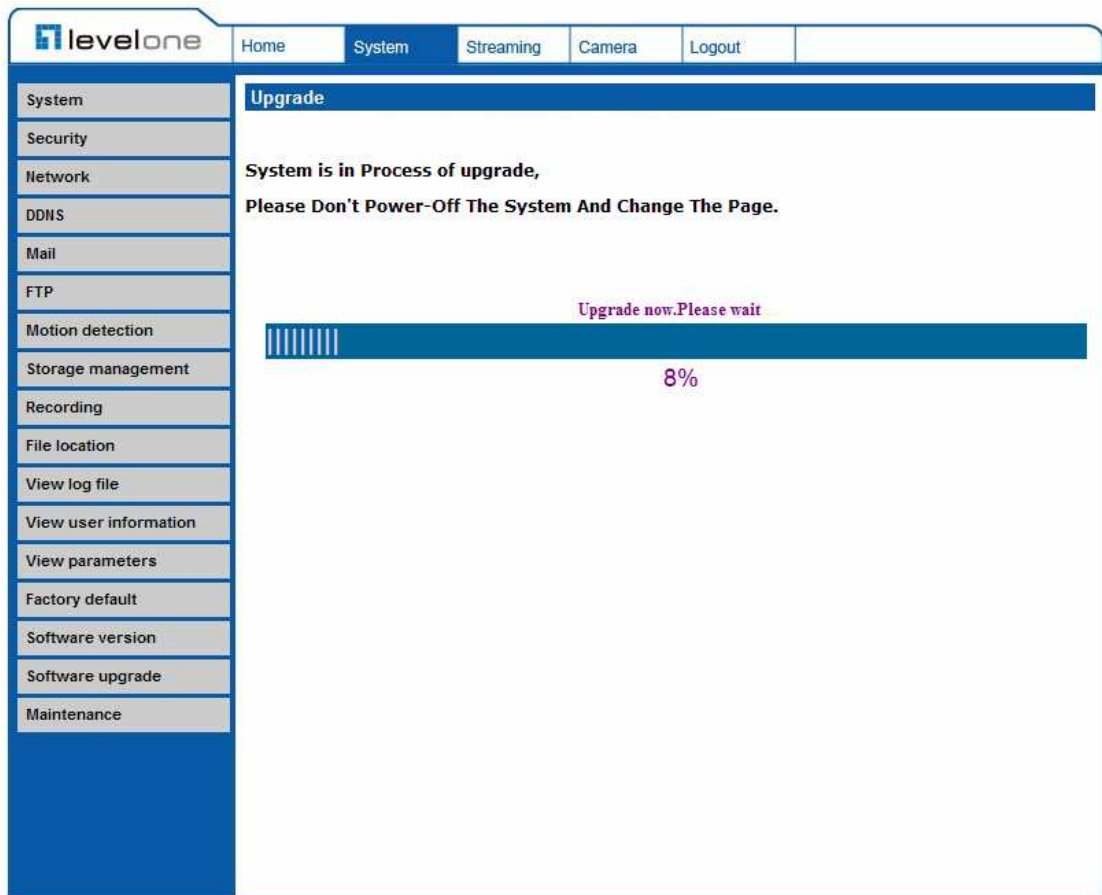

After the upgrade process is finished, the viewer will return to Home page.

**Step 4:** Close the video browser.

**Step 5:** Click “Control Panel”, and then double click “Add or Remove Programs.” In the “Currently install programs” list, select “DCViewer” and click the button “Remove” to uninstall the existing DC Viewer.

**Step 6:** Open a new web browser, re-login the IP Camera, and then allow the automatic download of DC Viewer.

## 4.3.17 Maintenance

Users can export configuration files to a specified location and retrieve data by uploading an existing configuration file to the IP Camera.

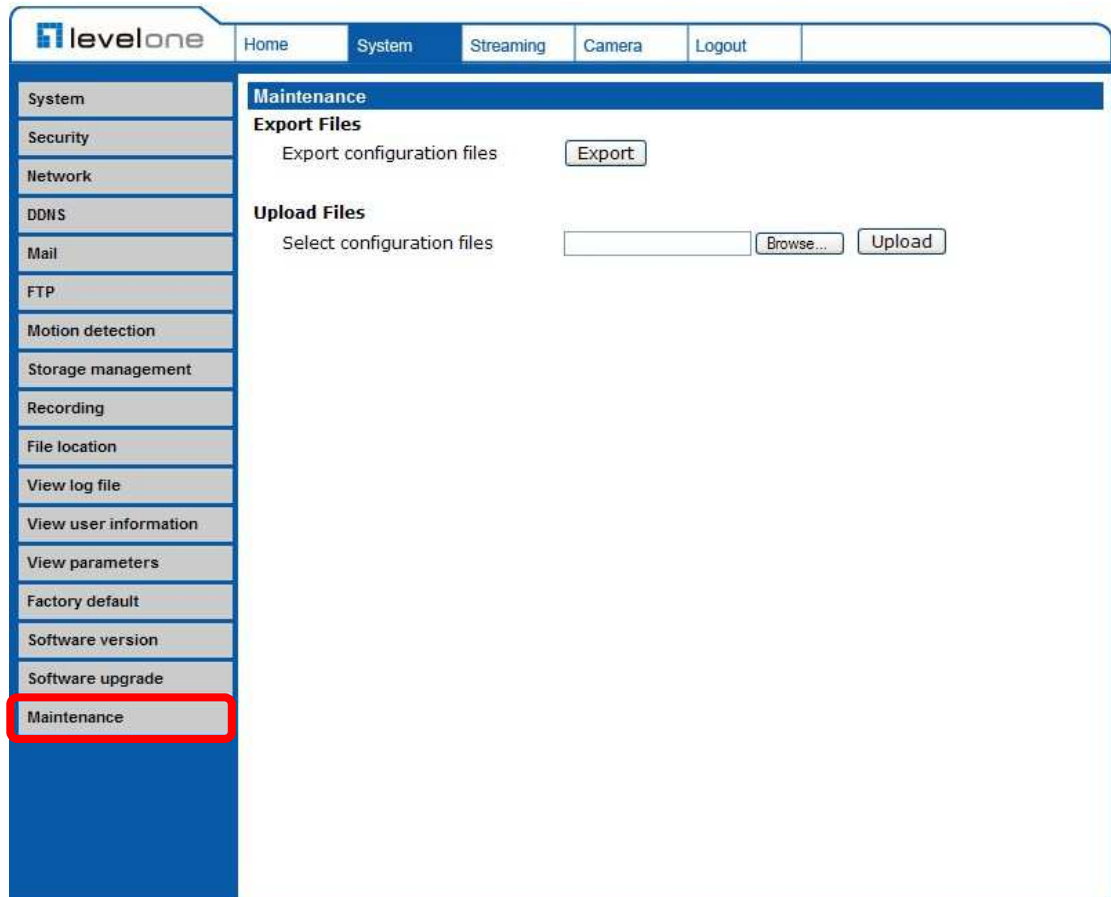

### Export

Users can save the system settings by exporting the configuration file (.bin) to a specified location for future use. Press the “Export” button, and the popup File Download window will come out as shown below. Click “Save” and specify a desired location for saving the configuration file.

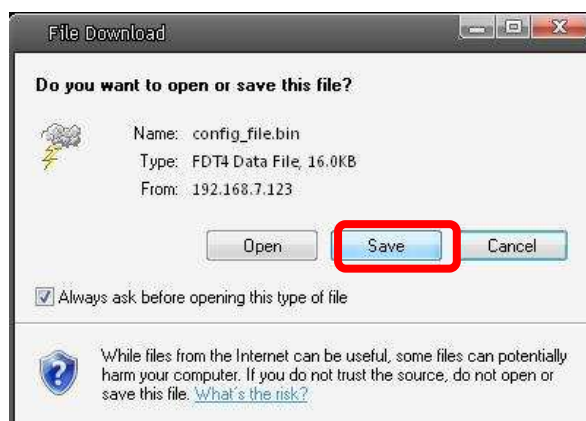

## Upload

To copy an existing configuration file to the IP Camera, please first click on “Browse” to select the configuration file, and then press the “Upload” button for uploading.

## 4.4 Video Streaming Settings

Press the tab “Streaming” in the top of the page, and the configurable video items will display in the left column. In Streaming, the Administrator can configure specific video resolution, video compression mode, video protocol, etc. Further details of these settings will be specified in the following sections.

### 4.4.1 Video Resolution and Rotate Type

The video setting page is shown below:

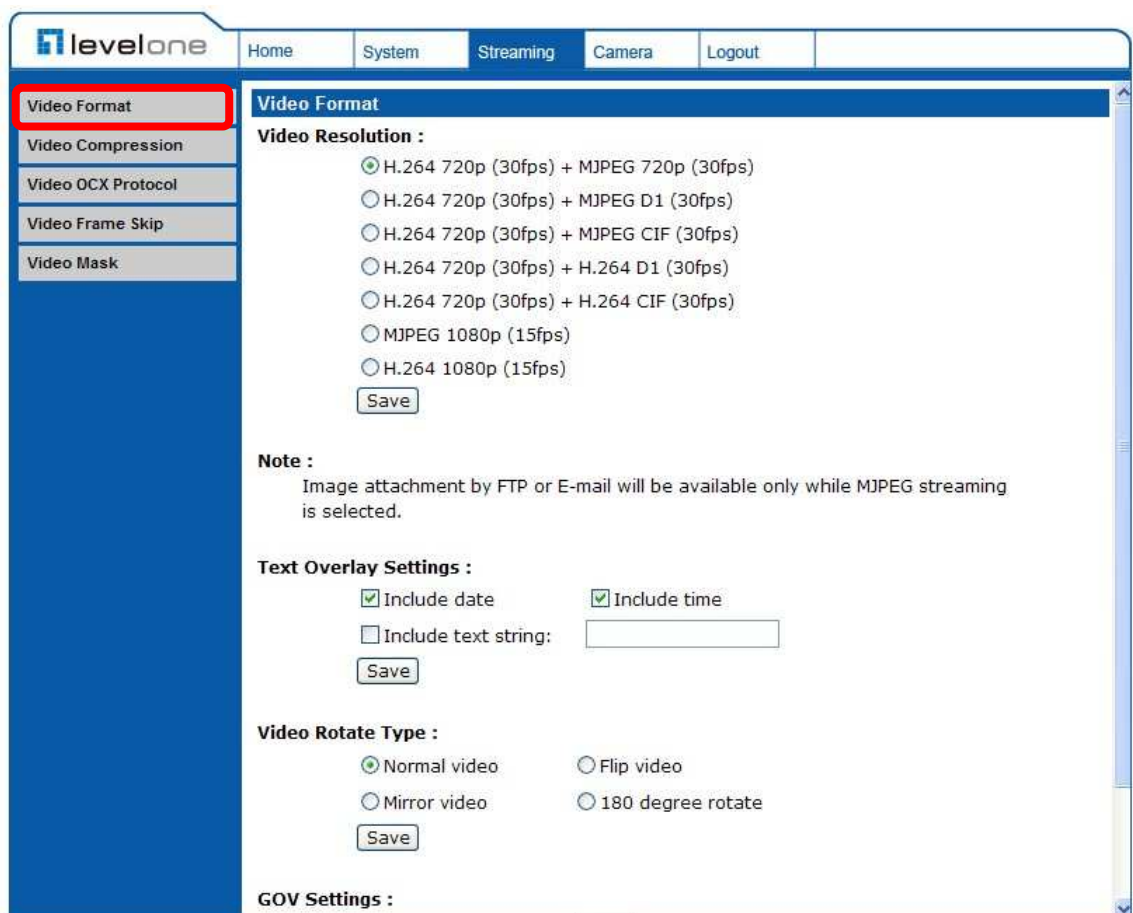

The screenshot displays the LevelOne web interface for video streaming settings. The top navigation bar includes 'Home', 'System', 'Streaming' (selected), 'Camera', and 'Logout'. A left sidebar contains menu items: 'Video Format' (highlighted with a red box), 'Video Compression', 'Video OCX Protocol', 'Video Frame Skip', and 'Video Mask'. The main content area is titled 'Video Format' and contains the following sections:

- Video Resolution :** A list of radio button options:
  - H.264 720p (30fps) + MJPEG 720p (30fps)
  - H.264 720p (30fps) + MJPEG D1 (30fps)
  - H.264 720p (30fps) + MJPEG CIF (30fps)
  - H.264 720p (30fps) + H.264 D1 (30fps)
  - H.264 720p (30fps) + H.264 CIF (30fps)
  - MJPEG 1080p (15fps)
  - H.264 1080p (15fps)A 'Save' button is located below the list.
- Note :** Image attachment by FTP or E-mail will be available only while MJPEG streaming is selected.
- Text Overlay Settings :** Includes checkboxes for 'Include date' (checked) and 'Include time' (checked). There is an unchecked checkbox for 'Include text string:' followed by an empty text input field. A 'Save' button is below.
- Video Rotate Type :** Includes radio button options for 'Normal video' (checked), 'Flip video', 'Mirror video', and '180 degree rotate'. A 'Save' button is below.
- GOV Settings :** This section is partially visible at the bottom of the page.

### **Video Format**

The IP Camera provides various video resolution like the following:

- H.264 720p (30fps) + MJPEG 720p (30fps)
- H.264 720p (30fps) + MJPEG D1 (30fps)
- H.264 720p (30fps) + MJPEG CIF (30fps)
- H.264 720p (30fps) + H.264 D1 (30fps)
- H.264 720p (30fps) + H.264 CIF (30fps)
- MJPEG 1080p (15fps);
- H.264 1080p (15fps)

Click “Save” to confirm the setting.

### **Text Overlay Settings**

Users can select the items to display data including date/time/text on the live video pane. The maximum length of the string is 20 alphanumeric characters.

Click “Save” to confirm the Text Overlay setting.

### **Video Rotate Type**

Users can change video display type if necessary. Selectable video rotate types include Normal, Flip, Mirror and 180 degree. Differences among these types are illustrated as below.

Suppose the displayed image of IP Camera is shown as the figure below.



To rotate the image, users can select “Flip”, for instance. Then the displayed image will be reversed as shown below.



The following is descriptions for different video rotate type.

- **Flip**  
If select <Flip>, the image will be rotated vertically.
- **Mirror**  
If select <Mirror>, the image will be rotated horizontally.
- **180 Degree**  
Selecting <180 Degree> will make the image 180° counter-/clockwise inversed.

Click “Save” to confirm the setting.

### **GOV Settings**

Users can set the GOV length to determine the frame contracture (I-frames and P-frames) in a video stream for saving bandwidth. Longer GOV means decreasing the frequency of I-frames.

Click “Save” to confirm the GOV setting.

## 4.4.2 Video Compression

Users can select a proper MJPEG/H.264 compression mode in the video compression page (see the figure below), depending on the application.

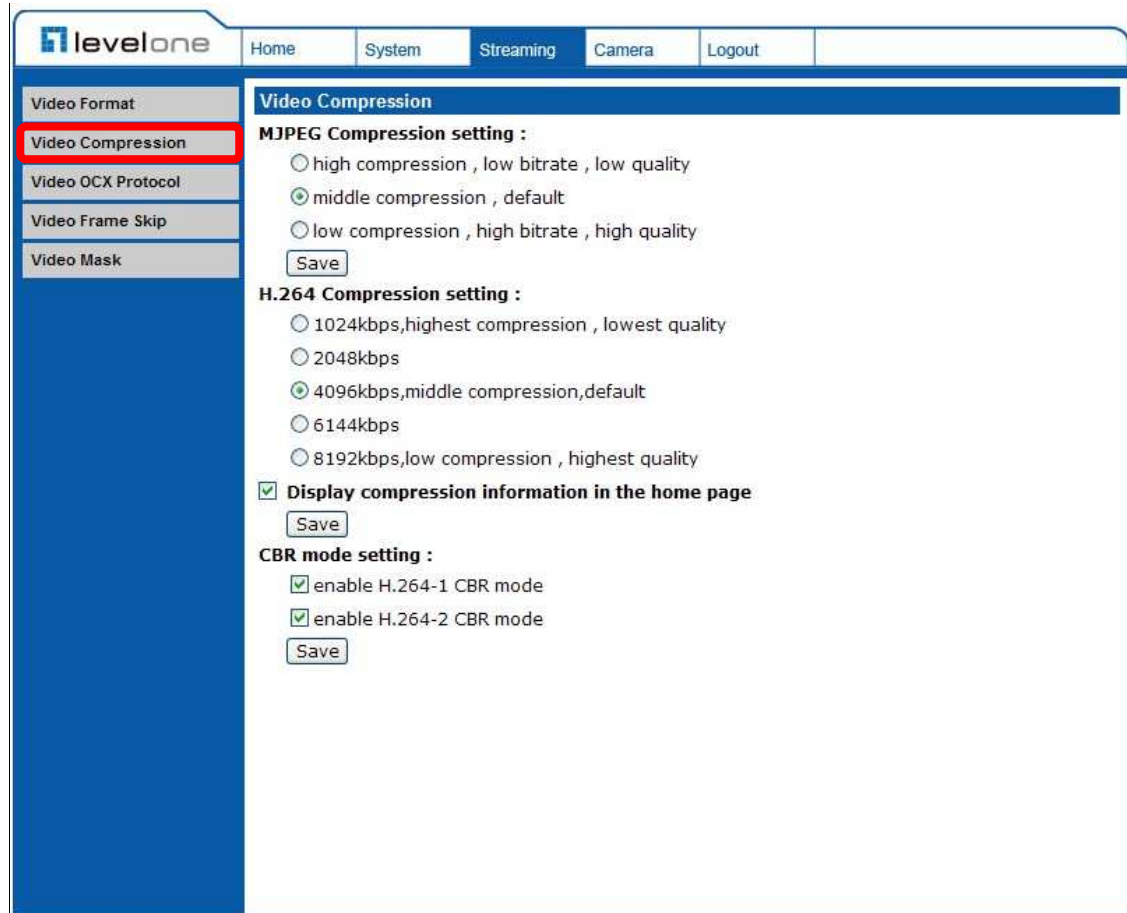

Users can also decide whether to display compression information on the Home page.

Click "Save" to confirm the setting.

## CBR Mode Setting

The screenshot shows the LevelOne web interface with the 'Streaming' tab selected. The left sidebar contains a menu with 'Video Compression' highlighted. The main content area is titled 'Video Compression' and contains the following settings:

- MJPEG Compression setting :**
  - high compression , low bitrate , low quality
  - middle compression , default
  - low compression , high bitrate , high quality
- H.264 Compression setting :**
  - 1024kbps, highest compression , lowest quality
  - 2048kbps
  - 4096kbps, middle compression, default
  - 6144kbps
  - 8192kbps, low compression , highest quality
- Display compression information in the home page**
- CBR mode setting :** (highlighted with a red box)
  - enable H.264-1 CBR mode
  - enable H.264-2 CBR mode

The CBR (Constant Bit Rate) mode could be the preferred bit rate mode if the bandwidth available is limited. It is important to take account of image quality while choosing to use CBR mode.

### 4.4.3 Video OCX Protocol

In the Video OCX protocol setting page, users can select RTP over UDP, RTP over TCP, RTSP over HTTP or MJPEG over HTTP, for streaming media over the network. In the case of multicast networking, users can select the Multicast mode. The page is shown as follows.

The screenshot shows the 'levelone' web interface. The top navigation bar includes 'Home', 'System', 'Streaming', 'Camera', and 'Logout'. On the left, a sidebar menu lists 'Video Format', 'Video Compression', 'Video OCX Protocol' (highlighted with a red box), 'Video Frame Skip', and 'Video Mask'. The main content area is titled 'Video OCX Protocol' and contains the following settings:

**Video OCX protocol setting :**

- RTP over UDP
- RTP over RTSP(TCP)
- RTSP over HTTP
- MJPEG over HTTP
- Multicast mode

Below these options are several input fields for multicast settings:

- Multicast IP Address:
- Multicast H.264-1 Video Port:
- Multicast H.264-2 Video Port:
- Multicast MJPEG Video Port:
- Multicast Audio Port:
- Multicast TTL:

A 'Save' button is located below the input fields. A 'Note:' section at the bottom states: 'This page only applies to video streams going to a DC Viewer.'

Video OCX protocol setting options include:

- RTP over UDP / RTP over RTSP(TCP) / RTSP over HTTP / MJPEG over HTTP

Select a mode according to your data delivery requirements.

- Multicast Mode  
Enter all required data, including multicast IP address, H.264 video port, MJPEG video port and TTL into each blank.

Click "Save" to confirm the setting.



## 4.4.4 Video Frame Skip

Video frame skipping is for saving bandwidth if necessary. The setting page is shown as below.

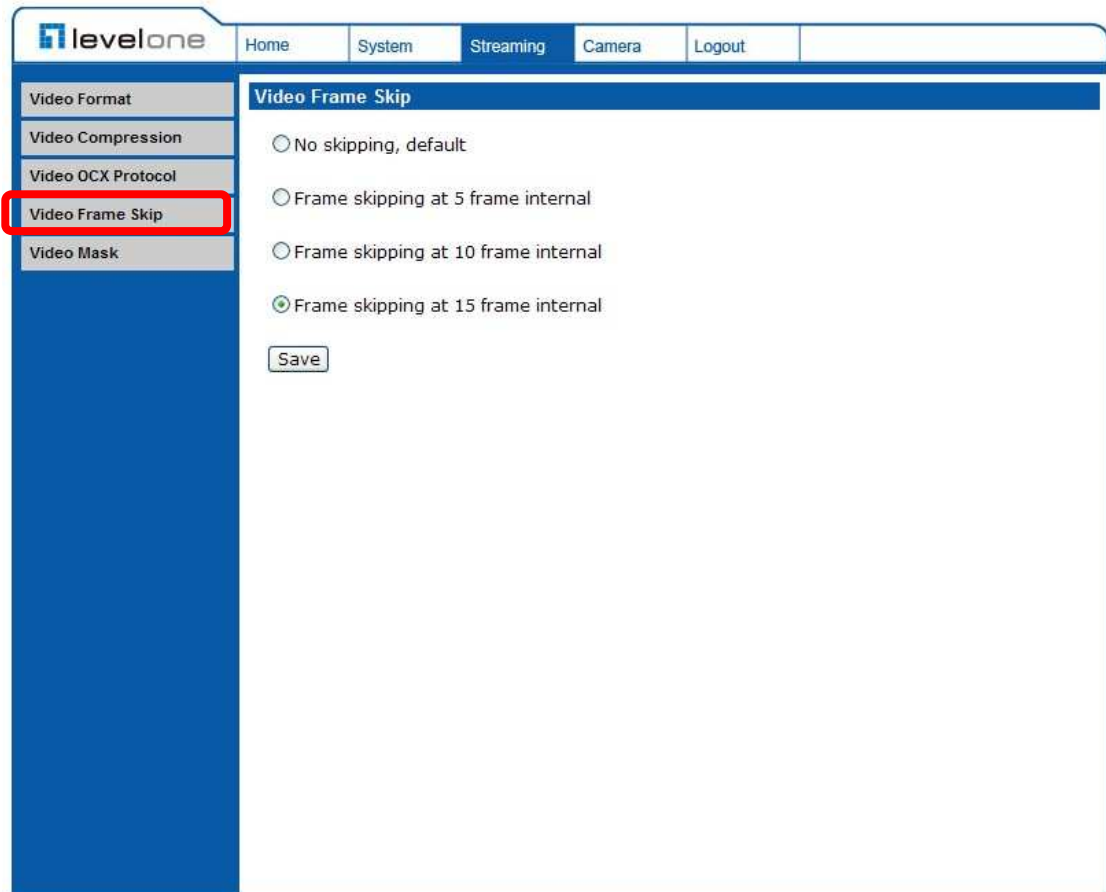

Video Frame Skip options include:

- No skipping, default
- Frame skipping at 5 frame internal
- Frame skipping at 10 frame internal
- Frame skipping to 15 frame internal



**NOTE:** Higher frame skipping rate will decrease video smoothness.

## 4.4.5 Video Mask

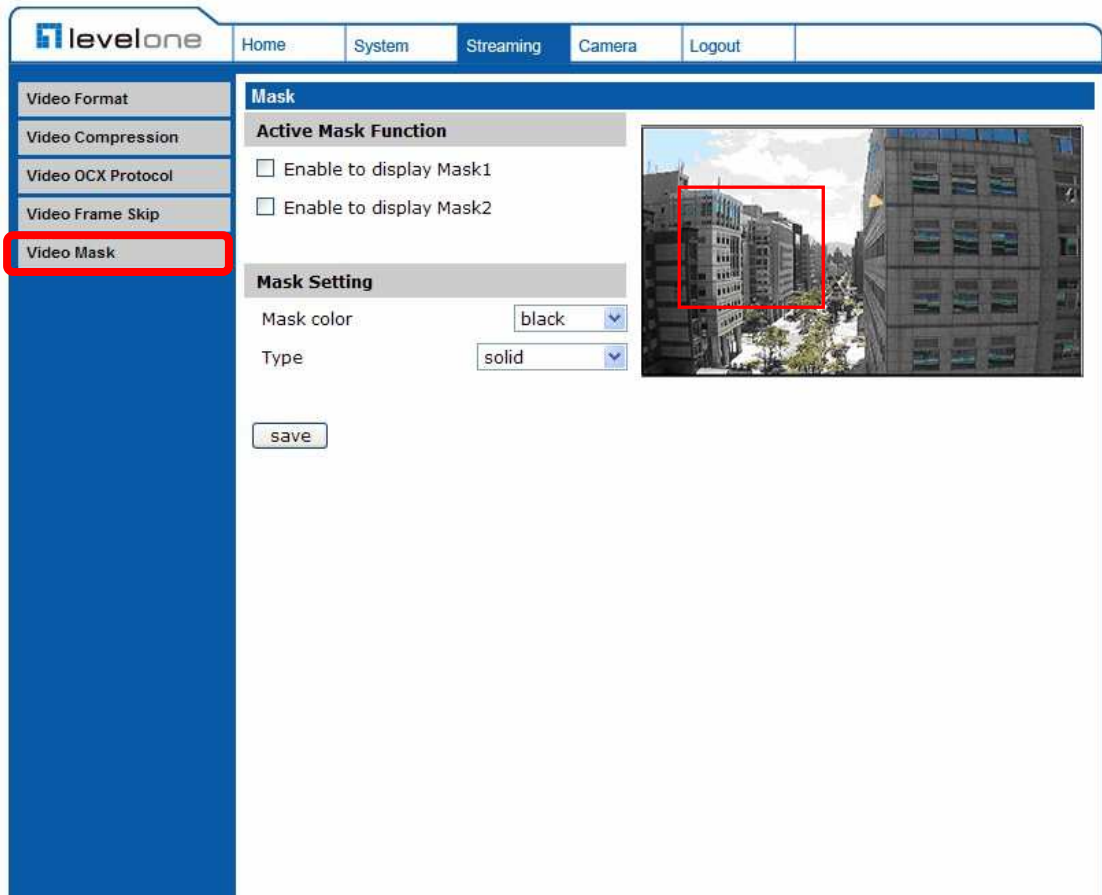

### Active Mask Function

- **Add a Mask**

Check a Video Mask checkbox, and a red frame will come out in the Live Video pane at the right side. Use the mouse to drag and drop to adjust the mask's size and place it on the target zone.



**NOTE:** It is suggested to set the Video Mask twice bigger than the object.

- **Cancel a Mask**

Uncheck the checkbox of the Video Mask meant to be deleted, and the selected mask will disappear from the Live Video pane instantly.

## Mask Setting

- **Mask color**  
The selections of Mask color include red, black, white, yellow, green, blue, cyan, and magenta.
- **Type**  
Select to change the mask type as solid or transparent.

## 4.5 Camera Settings

The figure below is the camera configuration page. Details of each parameter setting are described as follows.

The screenshot displays the LevelOne camera configuration interface. The top navigation bar includes 'Home', 'System', 'Streaming', 'Camera', and 'Logout'. The left sidebar contains settings for Exposure, White Balance, Brightness, Sharpness, Contrast, Saturation, Hue, and TV System, each with a 'Default' dropdown and a 'SET' button. The main content area features a live video feed of a city street, timestamped '2010/12/09 15:18'. Below the video, the 'Video format' is set to MJPEG (selected) with H.264 as an alternative. Resolution options include 'x1', 'x1/2', and 'Full'. Bitrate information is provided: MJPEG bitrate: middle compression, middle quality; H.264 bitrate: 4096kbps, middle compression.



**NOTE:** Please note that the function buttons will vary depending on the camera model.

### 4.5.1 Exposure Setting

The Exposure pull-down menu is shown as follows:

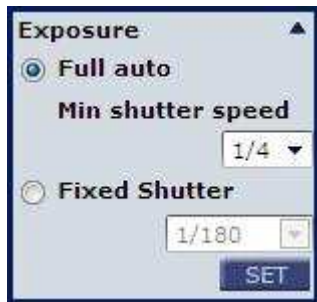

The exposure is the amount of light received by the image sensor and is determined by the width of lens diaphragm opening, the amount of exposure by the sensor (shutter speed) and other exposure parameters. With this item, users can define how the Auto Exposure function works.

Each exposure mode is specified as follows:

### **Full Auto Mode**

In this mode, the camera's Shutter Speed, IRIS and AGC (Auto Gain Control) control circuits work together automatically to get consistent video output level. The shutter speed range is from 1 to 1/8 sec. with 4 options. Users could select suitable shutter speed according to the environmental illuminance.

### **Fixed Shutter Mode**

In this mode, fixed shutter speed could be selected from the dropdown menu. The shutter speed range is from 1/10000 to 1 sec. with 19 options. Users could select suitable shutter speed according to the environmental illumination.

## 4.5.2 White Balance Setting

The White Balance pull-down menu is shown as follows:

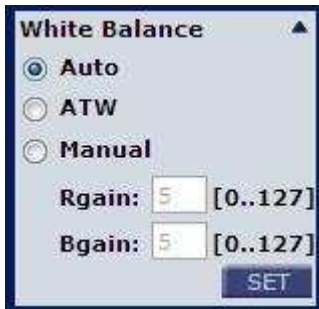

A camera needs to find reference color temperature, which is a way of measuring the quality of a light source, for calculating all the other colors. The unit for measuring this ratio is in degree Kelvin (K). Users can select one of the White Balance Control modes according to the operating environment. The following table shows the color temperature of some light sources for reference.

Light Sources	Color Temperature in K
Cloudy Sky	6,000 to 8,000
Noon Sun and Clear Sky	6,500
Household Lighting	2,500 to 3,000
75-watt Bulb	2,820
Candle Flame	1,200 to 1,500

### **Auto Mode**

The Auto Balance White mode is suitable for environment with light source having color temperature in the range roughly from 2700 ~ 8000K.

### **ATW Mode (Auto Tracking White Balance)**

With Auto Tracking White Balance function, the white balance in a scene will be automatically adjusted while temperature color is changing. The ATW Mode is suitable for environment with light source having color temperature in the range roughly from 2450 ~ 10500K.

### **Manual Mode**

In this mode, users can change the White Balance value manually. Users can select a number between 0 ~127 of "Rgain/ Bgain" item to gain the red/ blue illuminant on the Live Video Pane. Press <SET> to confirm the new setting.

### 4.5.3 Brightness Setting

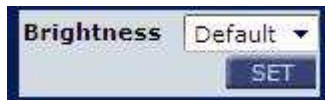

Users can adjust the image's brightness by adjusting the item. To increase video brightness, select a bigger number. Press <SET> to confirm the new setting.

### 4.5.4 Sharpness Setting



Increasing the sharpness level can make the image looked sharper; especially enhance the object's edge. Press <SET> to confirm the new setting.

### 4.5.5 Contrast Setting

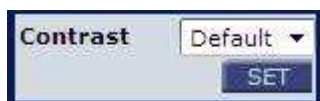

Camera image contrast level is adjustable; please select ranging from -6 to +19. Press <SET> to confirm the new setting.

### 4.5.6 Saturation Setting



Camera image saturation level is adjustable; please select ranging from -6 to +19. Press <SET> to confirm the new setting.

## 4.5.7 Hue Setting



Camera image hue level is adjustable; please select ranging from -12 to +13.  
Press <SET> to confirm the new setting.

## 4.5.8 TV System Setup

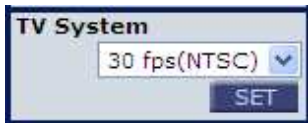

Select the video format that matches the present TV system.

## 4.6 Logout

Press the tab “Logout” in the top of the page, and the login window will pop up. This enables login with another user name.

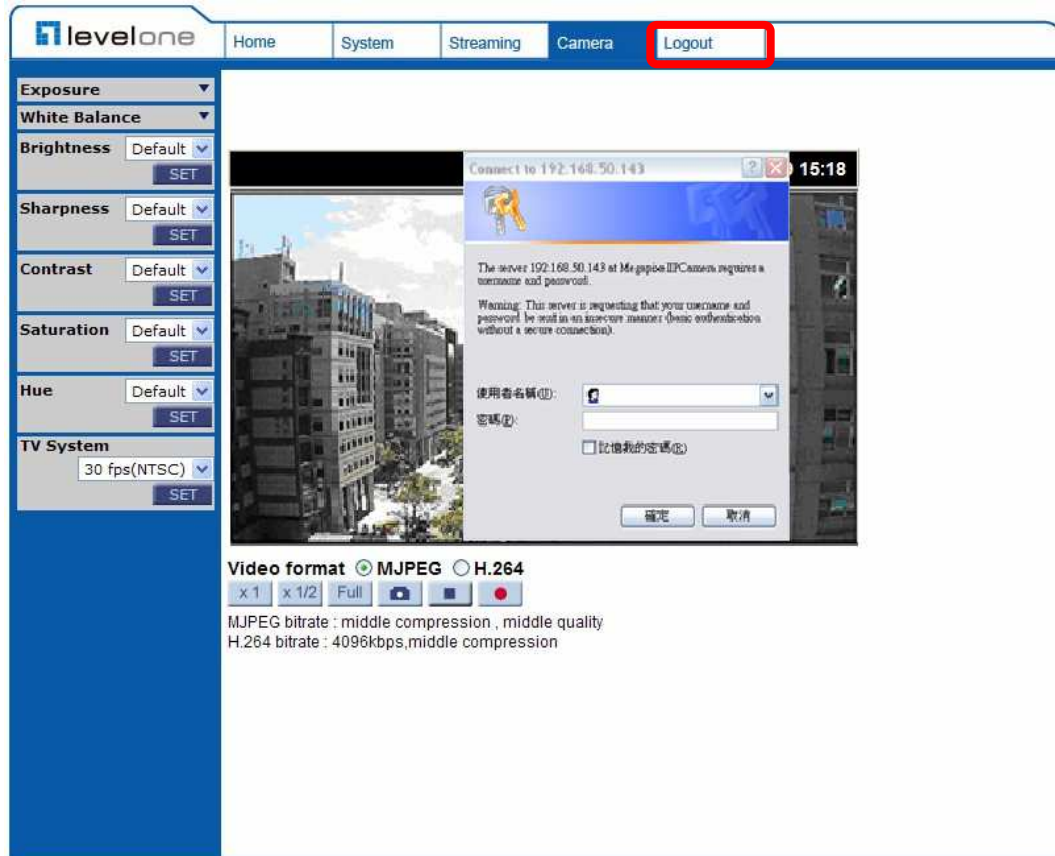



## Appendix A: Technical Specifications

Camera		Full HD
Image Sensor		1/2.7" Progressive CMOS
Picture Elements		1920(H) x 1080(V)
Minimum Illumination		0.1 lux @ F 1.6
Shutter Speed		1~ 1/10000 sec.
White Balance		Manual / AWB / ATW
Lens		
Fixed Lens		F 1.5 / f = 4.0 mm
FOV		78° (f = 4.0 mm)
Operation		
Video Compression		H.264/MJPEG
Video Streaming		Simultaneous H.264 + MJPEG Simultaneous H.264 + H.264
Resolution	H.264	Full-HD 1080p / HD 720p / D1 / CIF
	MJPEG	Full-HD 1080p / HD 720p / D1 / CIF
Frame Rate		HD 25 / 30 fps , Full HD 15 fps
Image Setting	Brightness	Manual
	Exposure	Auto / Manual
	Sharpness	Manual
	Contrast	Manual
	White Balance	Auto / Manual
	Saturation	Manual
	Hue	Manual
	Digital Zoom	Support
	Motion detection	On / Off
	Privacy Mask	2
Privacy Mask Type		Transparent, Color
Network		
Interface		10/100Mbps Ethernet (RJ-45)
Protocol		TCP/IP, UDP, RTP, RTSP, HTTP, ICMP, FTP, SMTP, DHCP, PPPoE, UPnP and IGMP
Password Levels		User and Administrator
Internet Browser		Internet Explorer (6.0+)
User Account		20
Mechanical		
Lens Mounting		M12 Board Lens
Connectors	Ethernet	RJ-45
	Micro SD; optional	SDHC support
General		
Operating Temperature		-20° ~ 50°C Humidity: 10% to 90%, No Condensation
Power Source		PoE
Power Consumption		3.8W

Regulatory	CE, FCC, RoHS Compliant
Dimension	∅117 x 50 mm (4.6 x 2.0 Inches)
Weight	180 g (0.40 lbs)

# Appendix B: Internet Security Settings

If ActiveX control installation is blocked, please either set Internet security level to default or change ActiveX controls and plug-ins settings.

## Internet Security Level: Default

**Step 1:** Start the Internet Explorer (IE).

**Step 2:** Select <Tools> from the main menu of the browser. Then Click <Internet Options>.

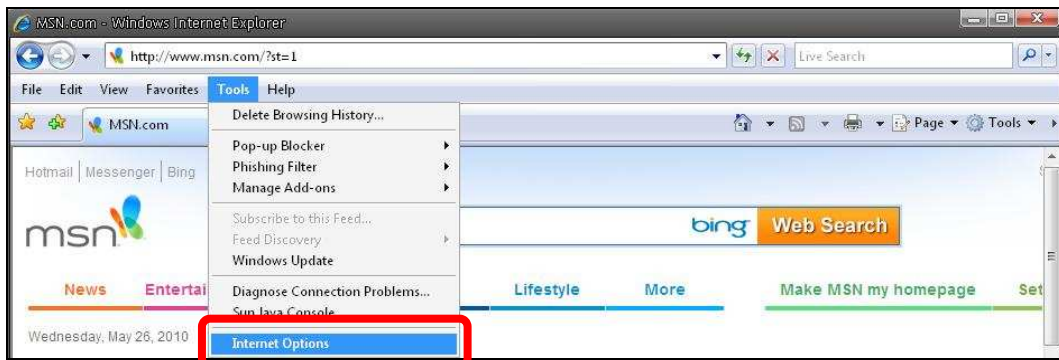

**Step 3:** Click the <Security> tab, and select <Internet>.

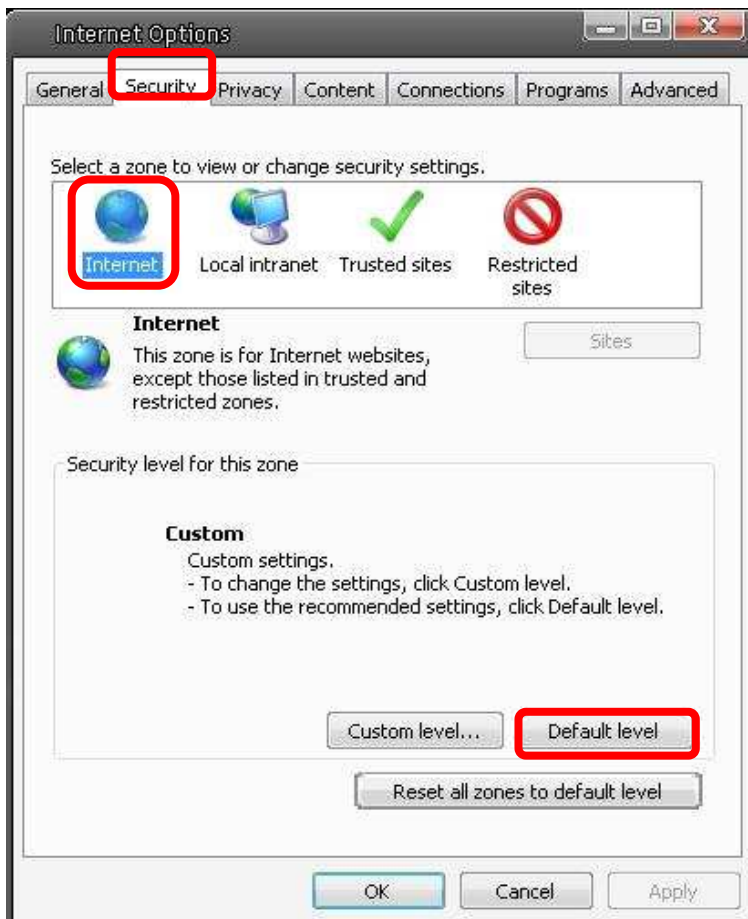

**Step 4:** Down the page, press “Default Level” (see the figure above) and click “OK” to confirm the setting. Close the browser window, and open a new one later when accessing the IP Camera.

### **ActiveX Controls and Plug-ins Settings**

**Step 1~3:** Refer to the previous section above.

**Step 4:** Down the page, press “Custom Level” (see the figure below) to change ActiveX controls and plug-ins settings.



The Security Settings screen is displayed as below:

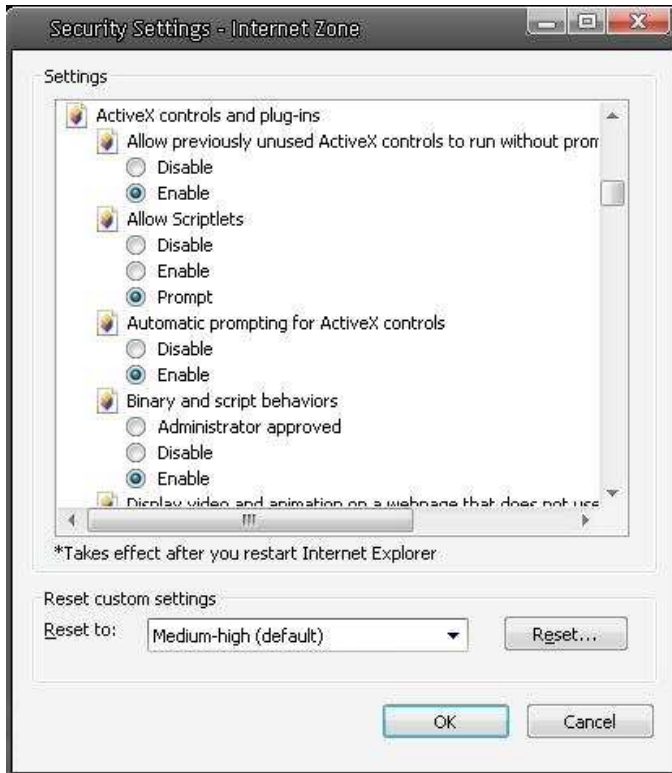

**Step 5:** Under “ActiveX controls and plug-ins”, set ALL items (as listed below) to <Enable> or <Prompt>.

**ActiveX controls and plug-ins settings:**

1. Automatic prompting for ActiveX controls
2. Binary and scrip behaviors
3. Download signed ActiveX controls
4. Download using ActiveX controls
5. Initialize and script ActiveX not marked as safe
6. Run ActiveX controls and plug-ins
7. Script ActiveX controls marked safe for scripting

**Step 6:** Click <OK> to accept the settings and close the <Security> screen.

**Step 7:** Click <OK> to close the Internet Options screen.

**Step 8:** Close the browser window, and restart a new one later for accessing the IP Camera.

# Appendix C: DC Viewer Download Procedure

The procedure of DC Viewer software download is specified as follows.

**Step 1:** In the DC Viewer installation page, click “Next” for starting installing.



**Step 2:** Setup starts. Please wait for a while until the loading bar runs out.

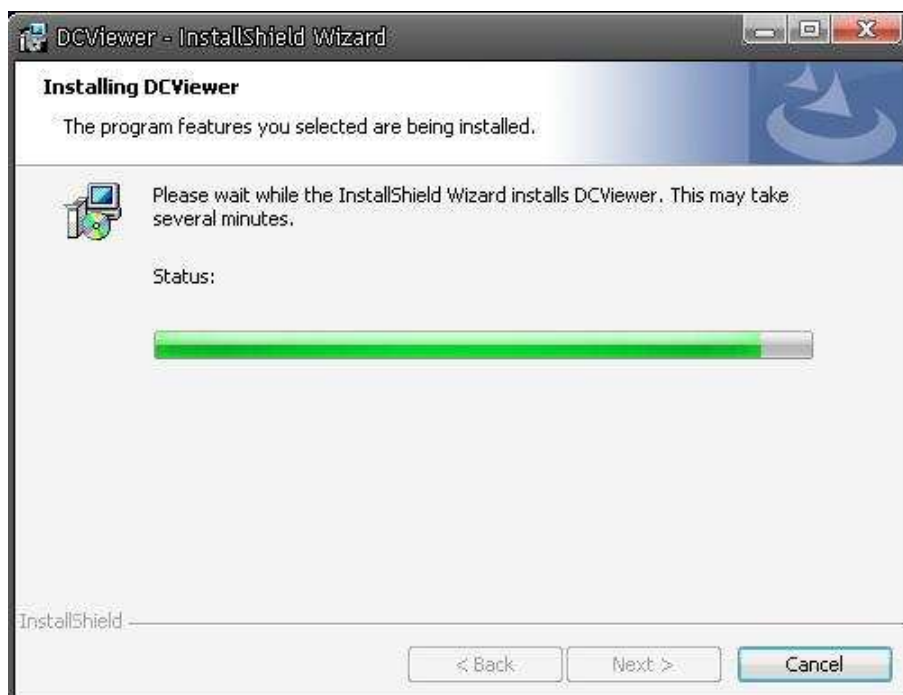

**Step 3:** Click “Finish” to close the DC Viewer installation page.

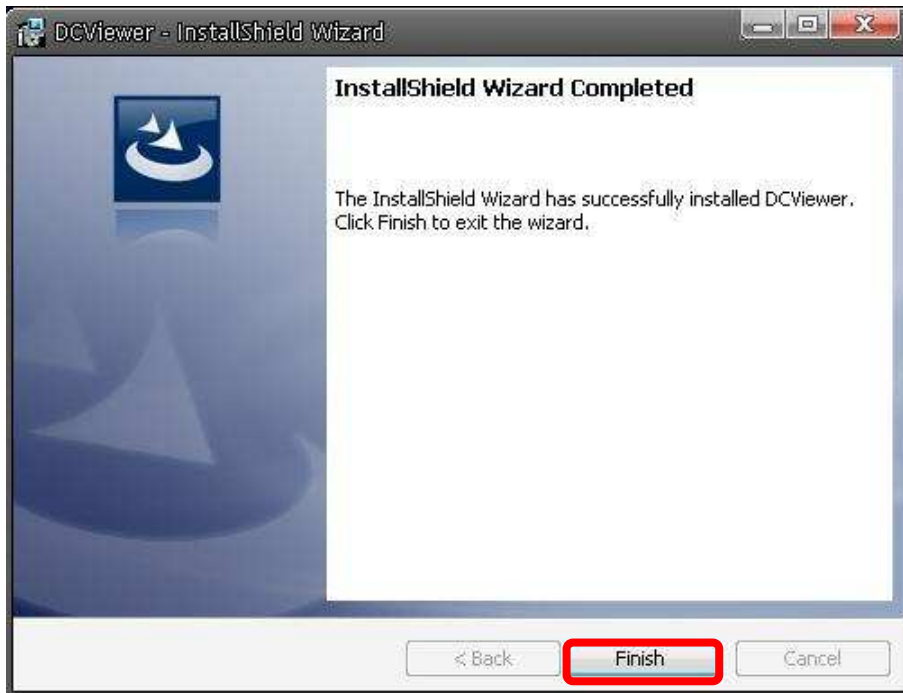

Then, the IP Camera’s Home page will display as follows:



**NOTE:** Please note that the function buttons will vary depending on the camera model.

# Appendix D: Install UPnP Components

Please follow the instructions below to install UPnP components.

**Step 1:** Go to “Start”, click on “Control Panel”, and then double click “Add or Remove Programs”.

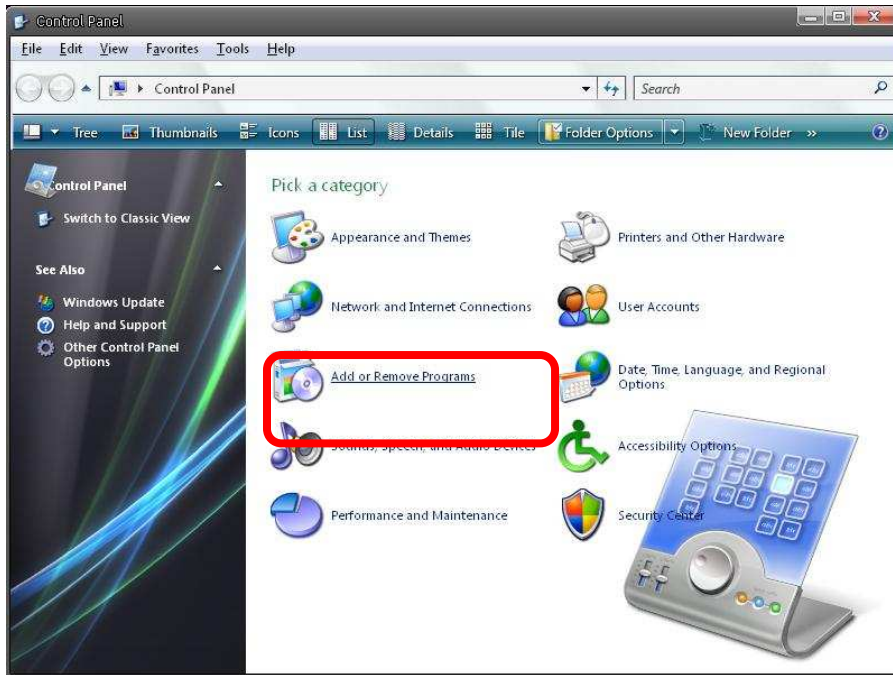

**Step 2:** Click on “Add/Remove Windows Components” in the Add or Remove Programs page..

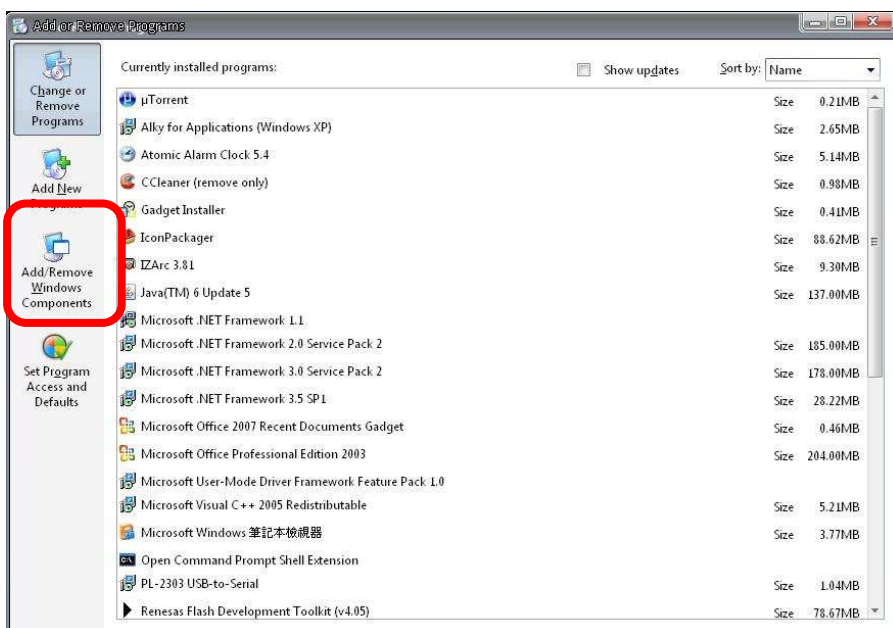



**Step 3:** Select “Networking Services” from the Components list in the Windows Components Wizard window, and then click “Details”.

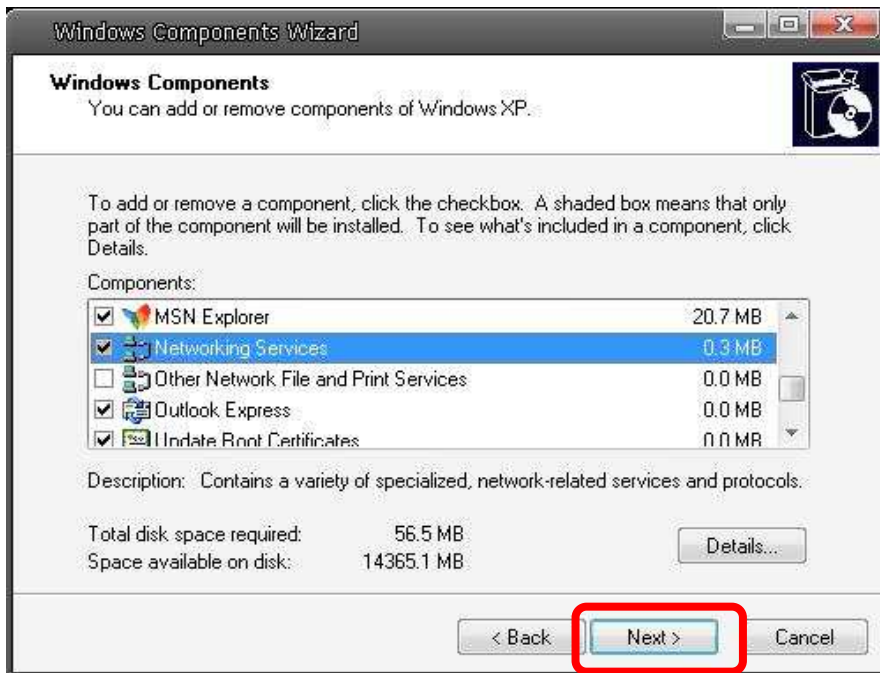

**Step 4:** Select “UPnP User Interface” in the Networking Services’ subcomponents list and then click “OK”.

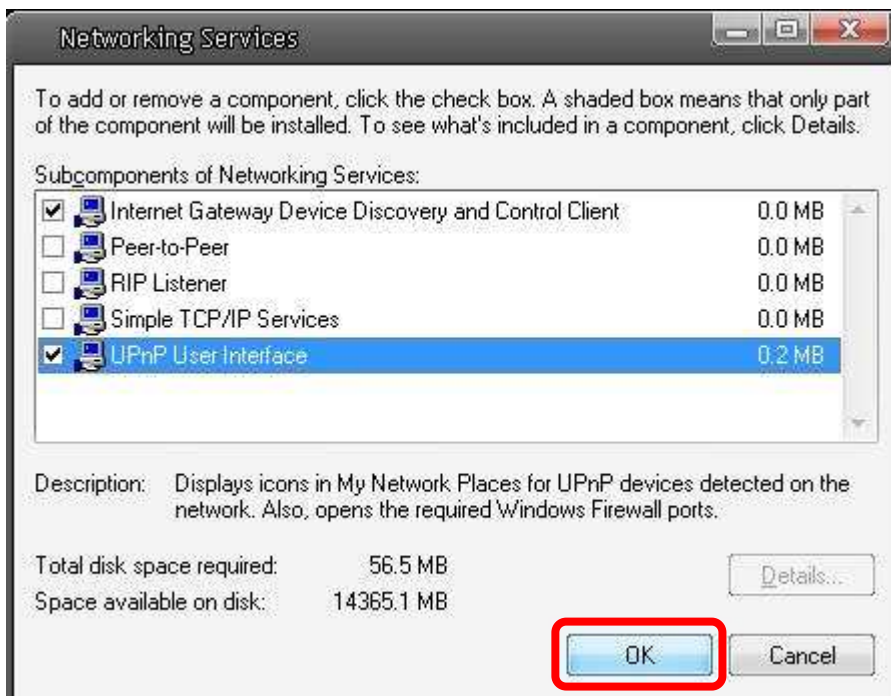

**Step 5:** Click “Next” in the Windows Components Wizard page.

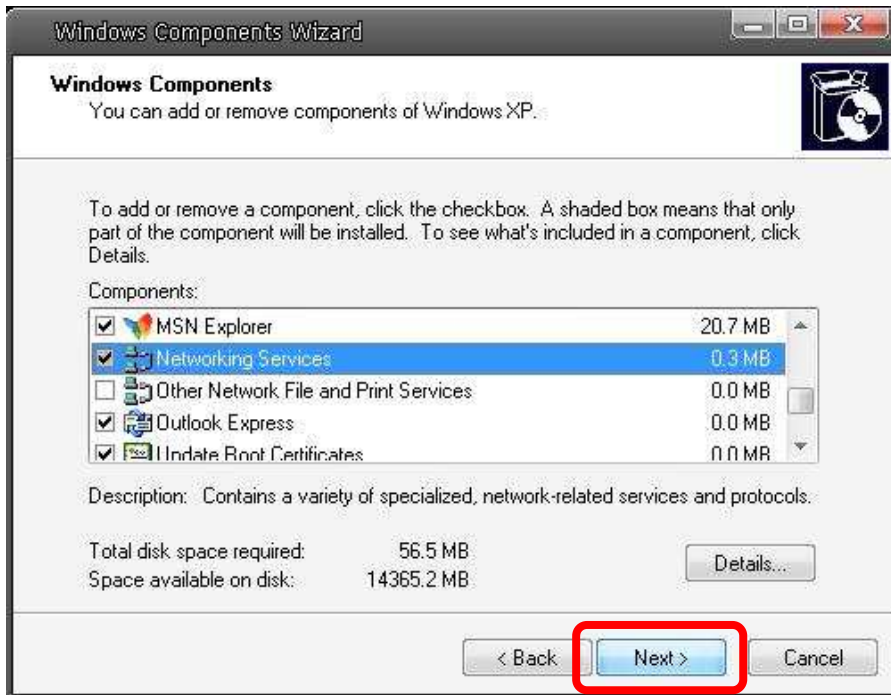

**Step 6:** Click "Finish" to complete installation.

