



LevelOne

User Manual

FCS-0030

H.264 MegaPixel PIR Lighting IP Camera

WCS-0030

Wireless H.264 MegaPixel PIR Lighting IP Camera

Ver 1.1

Product name:	Megapixel Cube Network Camera (WCS-0030/FCS-0030)	
Release Date:	2010/02/01	
Manual Revision:	V1.x	Firmware 1.x.x.x
Web site:	www.level1.com	

Default Settings

IP Address	DHCP
Username	admin
Password	admin

General Public License

This product incorporates open source code into the software and therefore falls under the guidelines governed by the General Public License (GPL) agreement.

Adhering to the GPL requirements, the open source code and open source license for the source code are available for free download at <http://global.level1.com>.

Table of Contents

Before You Use This Product	0
Cube Network Camera Overview	1
Device Appearance Description	3
LED Behavior	4
Installation	6
System Requirements	6
Camera Connection	7
Software installation	8
Access to the Network Camera	15
Check Network Settings	15
Add Password to prevent Unauthorized Access	15
Authentication	16
Installing plug-in	16
Live View	18
Configuration	21
Administrators can access the configuration page.	21
Camera/Video/Audio	21
Camera	21
Video	23
Audio	26
Multicast	27
Network	28
IP Setting	28
UPnP	29
DDNS (dynamic domain name service)	30
TZO	31
Easy Link	31
Wireless	32
Basic Settings	32
Security	32
WEP	32
Site Survey	33
WPA-Personal	34
WPA2-Personal	35
Advanced Settings	35
Wi-Fi Protected Setup	36

HTTP/HTTPS	37
Event	37
Motion Detection	37
Notification setting	38
Scheduled Event	42
PIR	43
System Log	44
Date & Time Settings	45
Device Information	46
Maintenance	48
User Management	48
IP Filter	49
Firmware Upgrade	49
Configuration	50
Reset to default	50

Before You Use This Product

The use of surveillance devices may be prohibited by law in your country. The Network Camera is not only a high-performance web-ready camera but also can be part of a flexible surveillance system. It is the user's responsibility to ensure that the operation of such devices is legal before installing this unit for its intended use.

It is important to first verify that all contents received are complete according to the list in the "Package Contents" chapter. Take notice of the warnings in "Quick installation guide" before the Network Camera is installed, then carefully read and follow the instructions in the "Installation" chapter to avoid damages due to faulty assembly and installation.

Package Contents

- Camera
- CD Manual/utility
- QIG
- Camera Stand
- Power Adapter

Cube Network Camera Overview

Compact designed Level1 FCS-0030/WCS-0030 offers high video quality surveillance solution for residences and small businesses. Unlike general webcam, Level1 FCS-0030/WCS-0030 camera is a standalone complete system that does not need to be connected to a computer. The built-in web server allows user to access over local area network (LAN) and through the internet via a web browser for live viewing and intercom functions. Enhanced facility for user, live viewing can also be supported via 3GPP phone and MSN.

Wireless capacity makes it easy to mount the device anywhere such as wall or desktop. 802.11b/g/n wireless with WPS and Ethernet connectivity can be integrated with an existing network environment. “Easy Installation Wizard” also allows user to configure device easily, even without IT background. Furthermore, the fashionable and streamline shape let the FCS-0030/ WCS-0030 not only a network camera, but also a decoration device.

The FCS-0030/WCS-0030 helps user monitor closely on family members, pets, offices, properties or anything valuables.

Pet monitor - Office workers can monitor pet in the house anytime, and also deliver voice by built-in speaker to let pet feel that the Owner is nearby

Residence monitor - Built-in PIR sensor can detect stranger intruding, which can trigger illumination LED, and send alert with snapshot in email or MMS to user’s portable device.

Labor monitor - Labor can be monitored when user is outside, and images also can be recorded and stored in micro SD.

The elderly and baby care - The elderly and baby can be cared easily by live view and intercom.

Small office surveillance - Employees working status can be monitored by portal device.

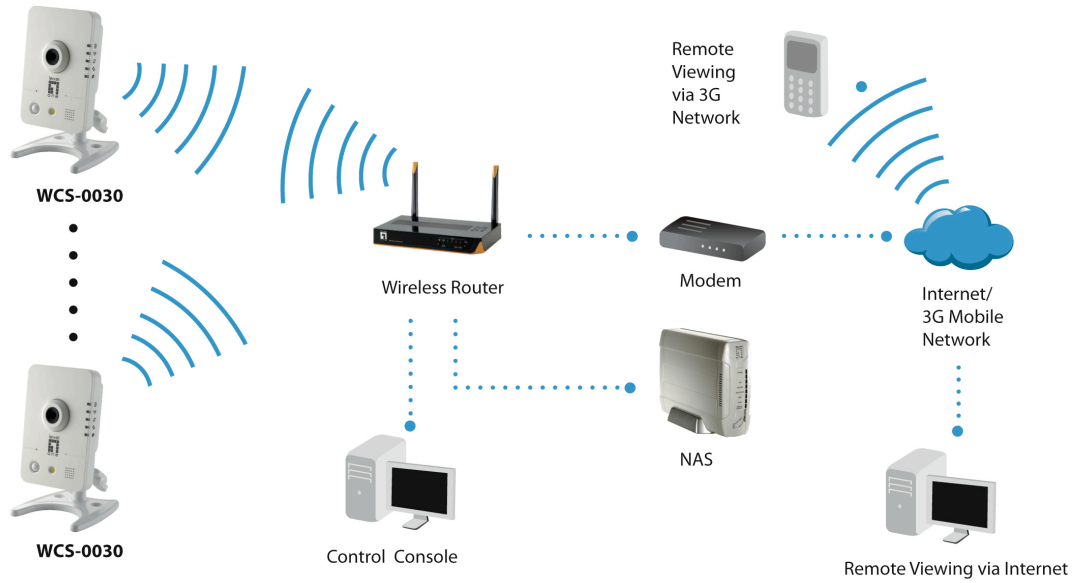

Device Appearance Description

< Front & Rear view >

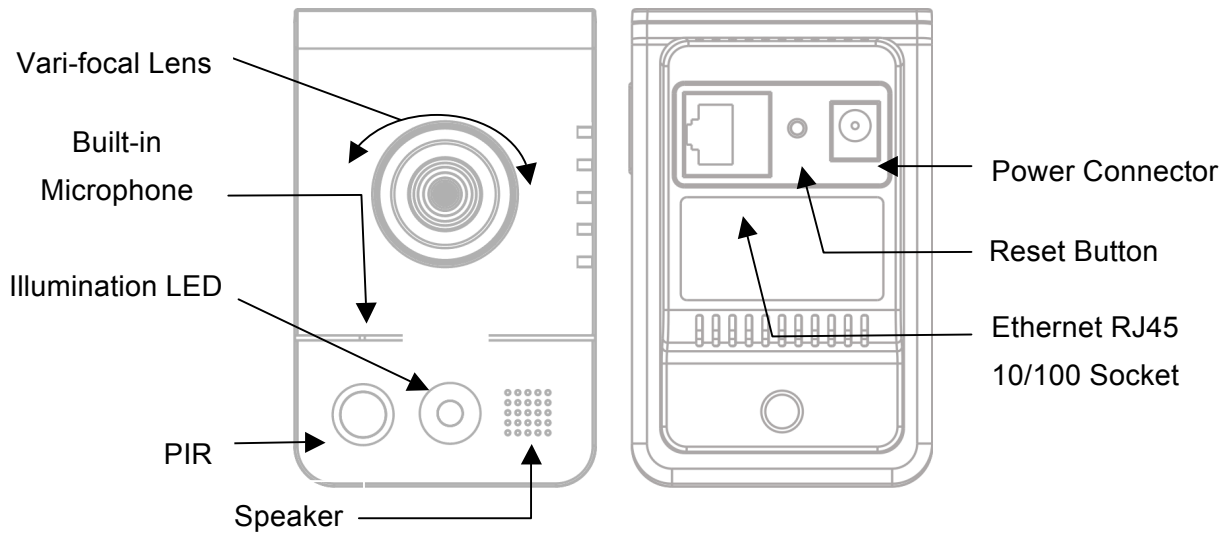

<Side view>

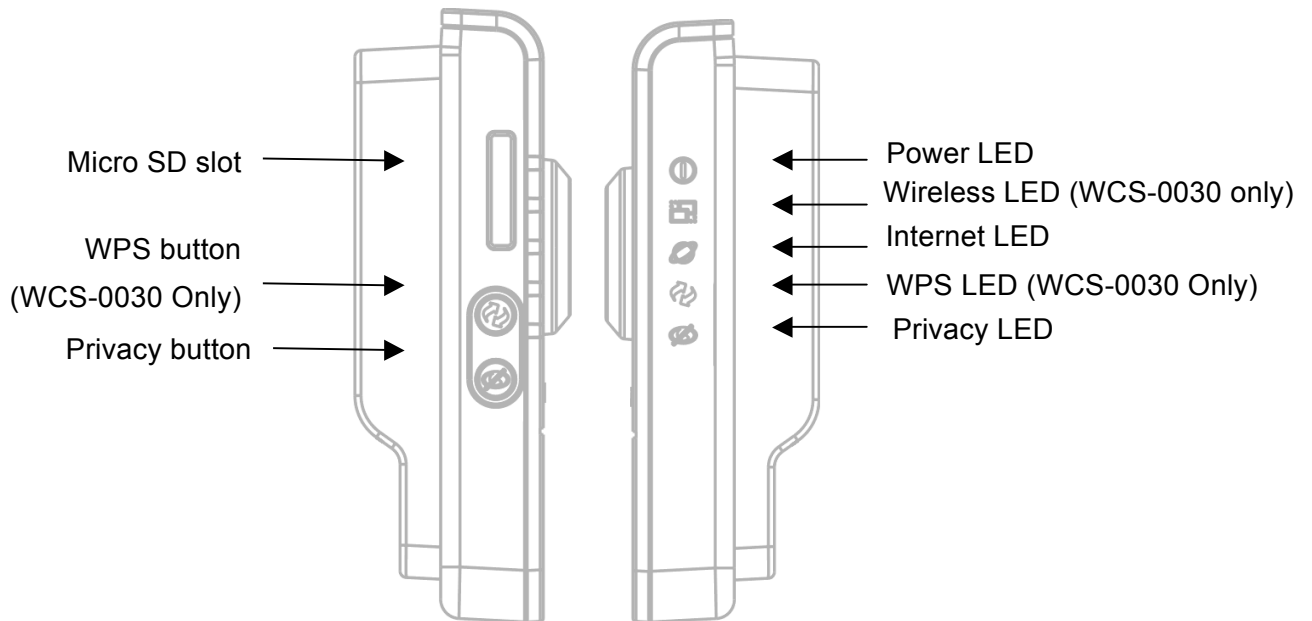

LED Behavior

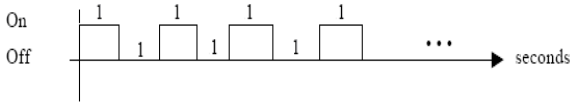
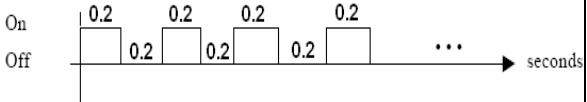
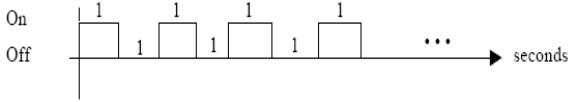
Function	LED Behavior	Description	Remark
Power	Steady On	Normal Operation	Top (Blue)
Power	Unlighted	Power off	Top (Blue)
Status	Steady On	1. Connect to switch by Ethernet or WiFi. 2. Reset to default.	Second (Blue)
Status	Unlighted	1. Power off 2. No connection	Second (Blue)
Status		1. While F/W upgrading 2. While WiFi site survey performing	Second (Blue)
Status	Blinking	1. While network connection in progress 2. Restoring settings.	Second (Blue)
Internet	Steady On	Connect to Internet	Third (Blue)
Internet	Unlighted	1. Power off 2. No connection	Third (Blue)
WPS		WPS in progress	Fourth (Blue)
WPS		WPS Error	Fourth (Blue)

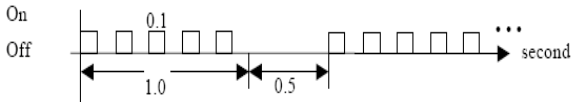
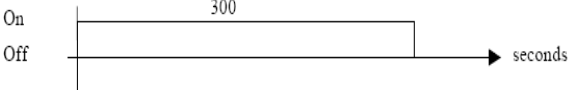
WPS		Session overlap detected	Fourth (Blue)
WPS		WPS Success	Fourth (Blue)
Privacy	Steady On	Privacy mask active	Bottom
Privacy	Unlighted	Privacy mask inactive	Bottom

Hardware Reset

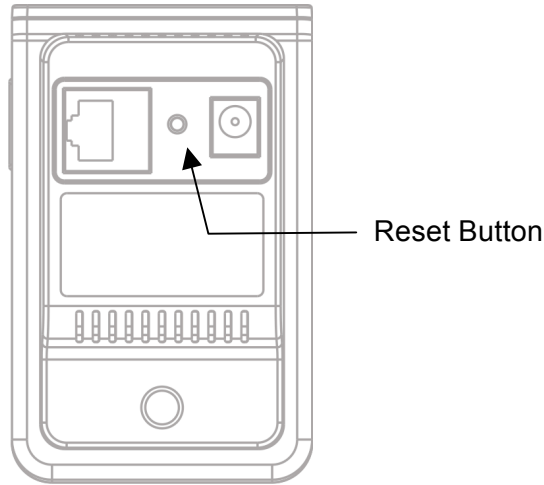

The reset button is used to reset the system or restore the factory default settings. Sometimes resetting the system can return the camera to normal operation. If the problems remain after reset, please restore the factory settings and install it again.

Reboot - Please press and release the indented reset button within 1 second with paper clip or thin object. Wait for the network camera to reboot.

Restore - Please press and hold the reset button until the status of LED turns off. It takes about 10 seconds. Please note that all settings will be restored to factory default. Upon successful restore, the status of LED will be blue again during normal operation.

Micro-SD Card Capacity

The network camera is compliant with Micro-SD/SDHC (Maximum 32GB) cards.

Installation

System Requirements

Operating System

Microsoft Windows XP Home Edition SP2

Microsoft Windows XP Professional SP2

Computer

IBM PC/AT Compatible

CPU

Pentium 3GHz or faster

Memory

1024 MB or more

Monitor

1024 x 768 pixels or more, 24-bit True color or better

Network Interface

10/100Mbps Network interface card must be installed

Web Browser

Microsoft Internet Explorer 6.0 SP2

CD-ROM Drive

It is necessary to read the operating instructions in the provided CD-ROM.

Adobe Reader

It is necessary to read the operating instructions in the provided CD-ROM.

- Audio function will not be working if a sound card is uninstalled on PC. Audio may be interrupted depending on the network environment.

Camera Connection

Basic Connection

1. Connect the supplied power cable from the camera to the power outlet.
2. Connect the camera to a switch via Ethernet cable.

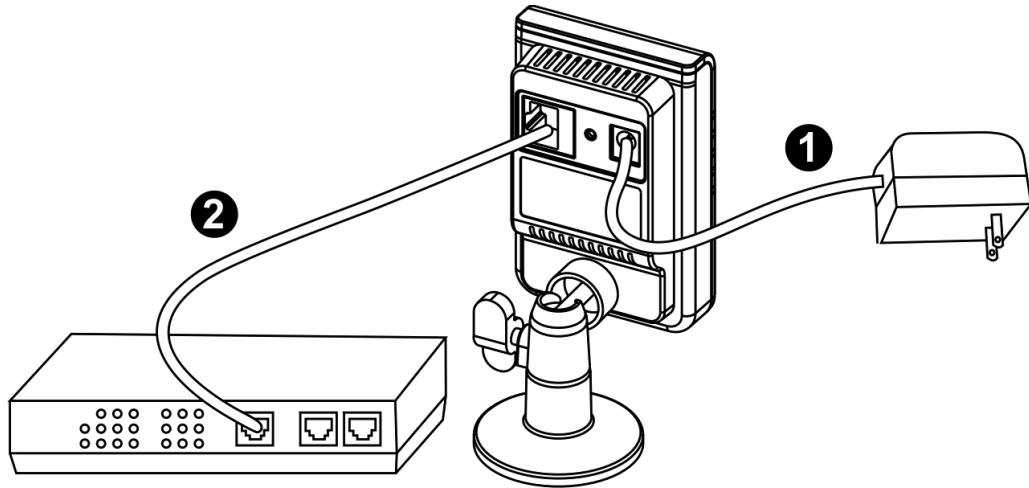

Please check your product package contains all the accessories listed in the foregoing Package Contents. Upon powering up, the power LED will become lighted first and then the device will go through booting process. The status LED will be steady amber for getting IP address. After getting IP Address, the link LED will blink orange while network connection is processing.

Software installation

In this manual, "User" refers to whoever has access to the Network Camera, and "Administrator" refers to the person who can configure the Network Camera and grant user access to the camera.

After hardware connection checking, the users can run the Installation Wizard program included in the product CDROM to automatically search for the Network Camera in the Intranet. There may be many Network Cameras in the local network. Users can differentiate the Network Cameras with the serial number. The serial number is printed on the labels on the carton and the bottom of the Network Camera body.

1. Insert the Installation CD into the CD-ROM driver. Click install and shows the welcome screen. Follow the steps to install the Installation wizard on user's computer.

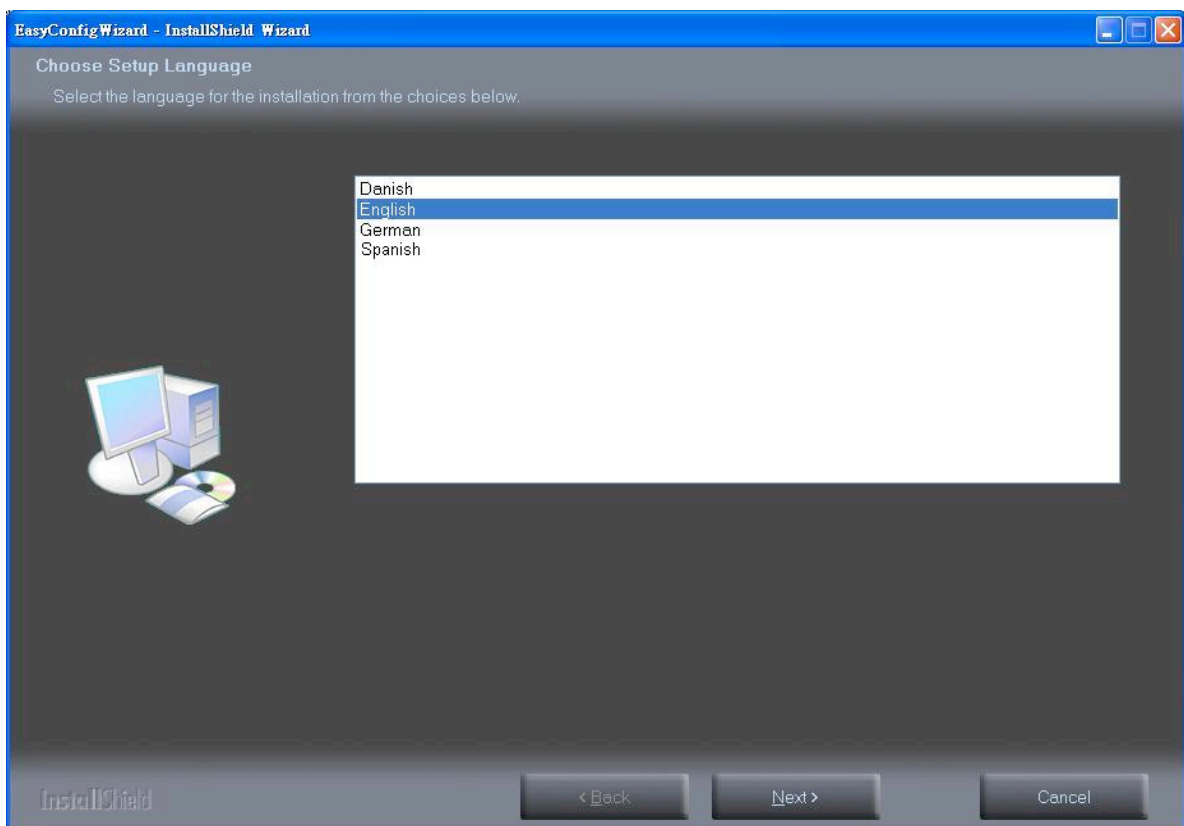

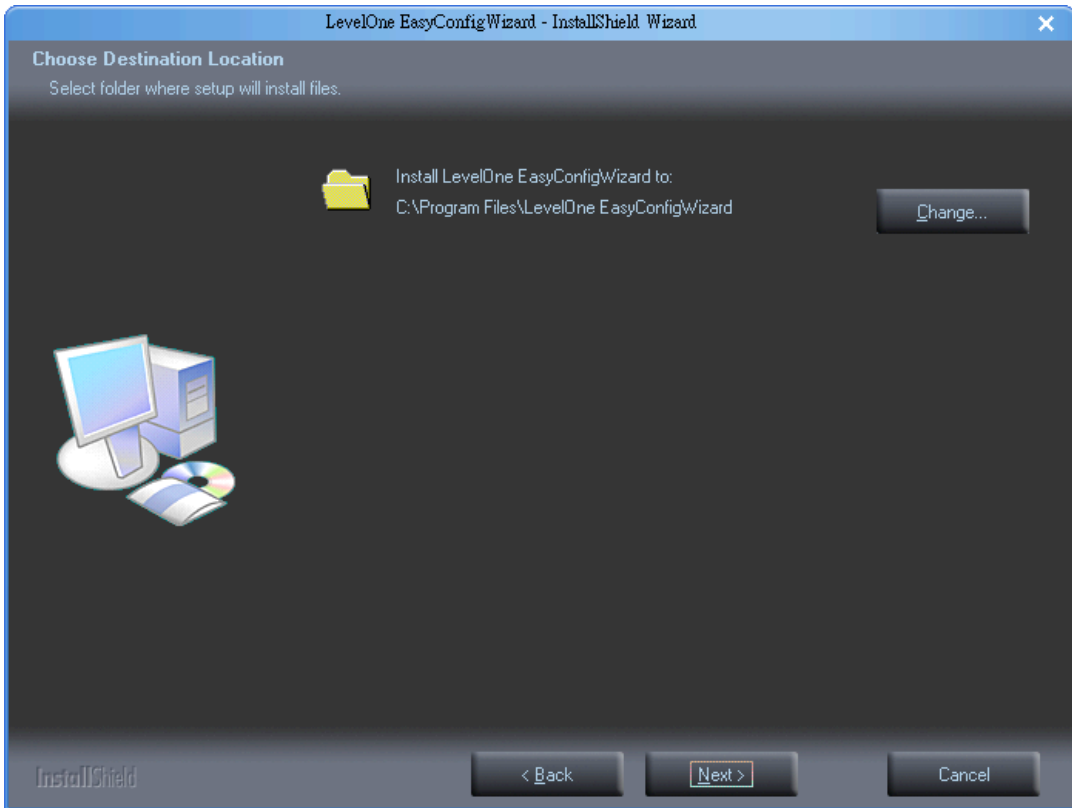
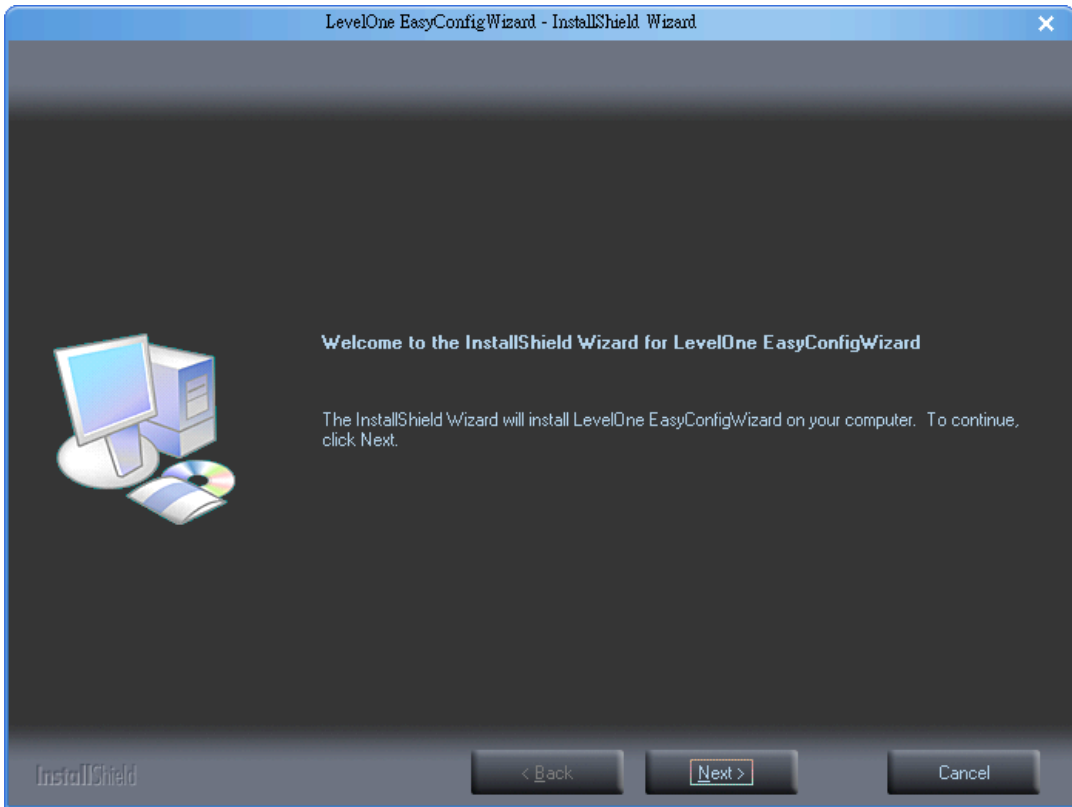

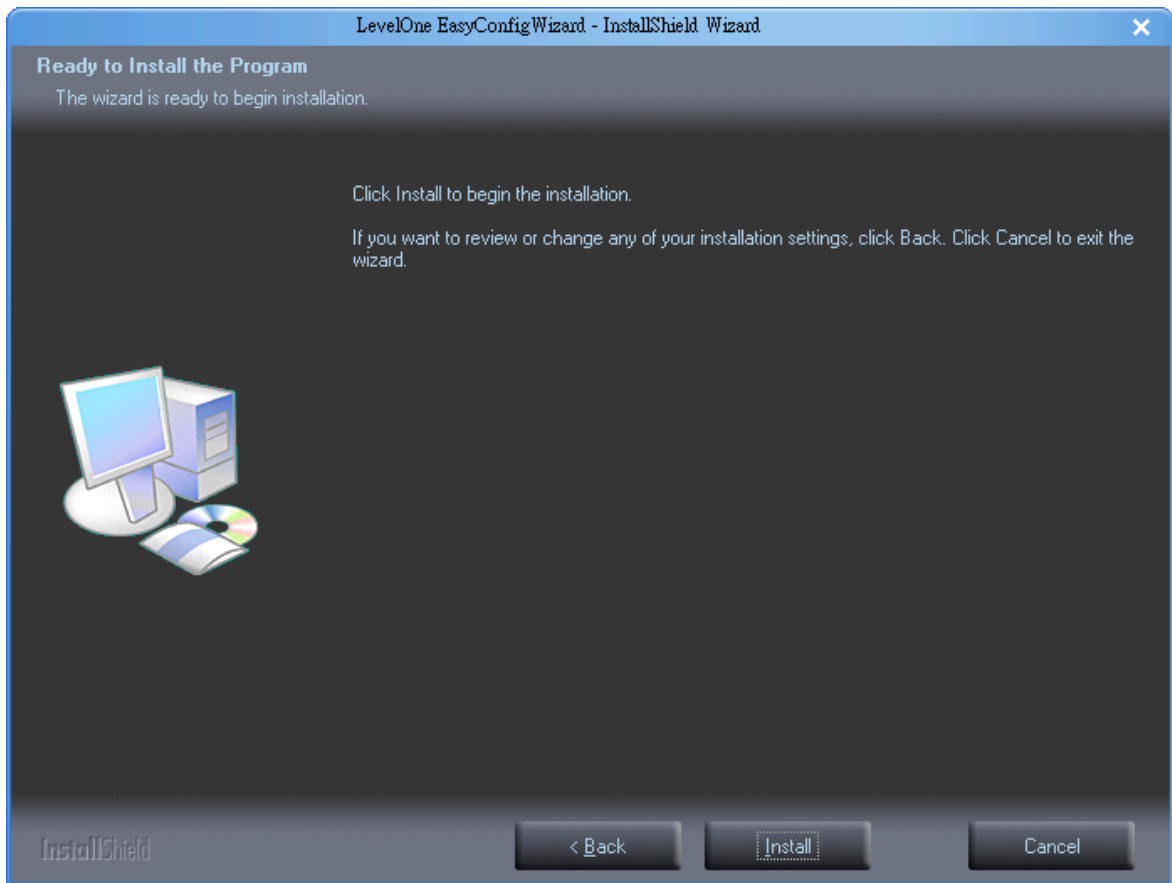

-
2. Do not check the box if user would like to check the hardware installation settings, Otherwise click "Skip the hardware installation" to skip the hardware connection checking, the program will automatically search for the Network Camera in the Intranet. Click "Start" to continue.

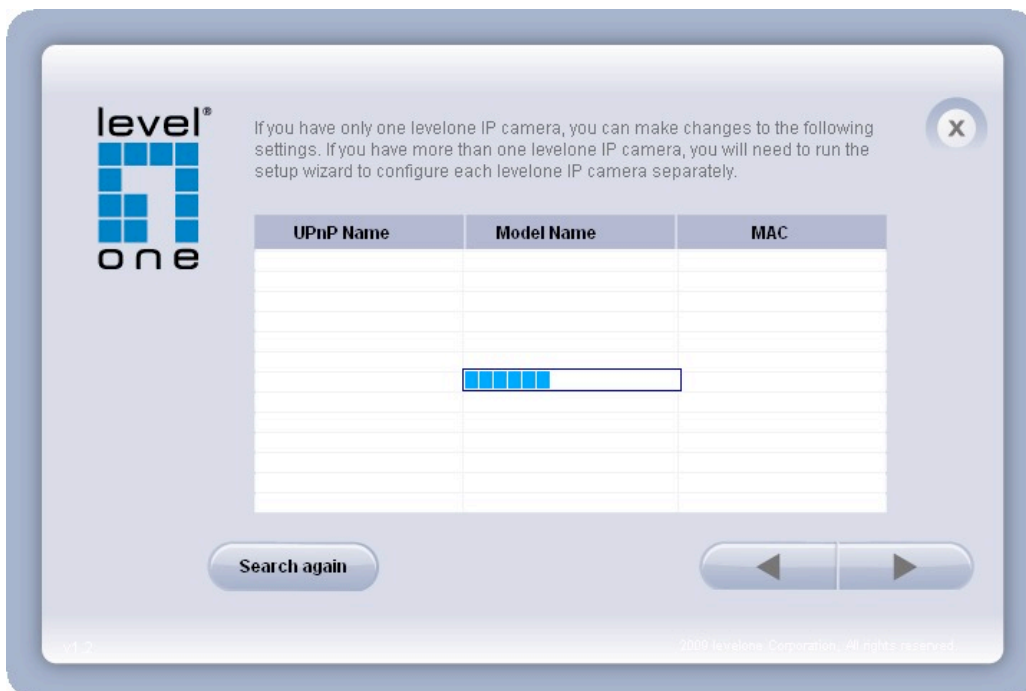
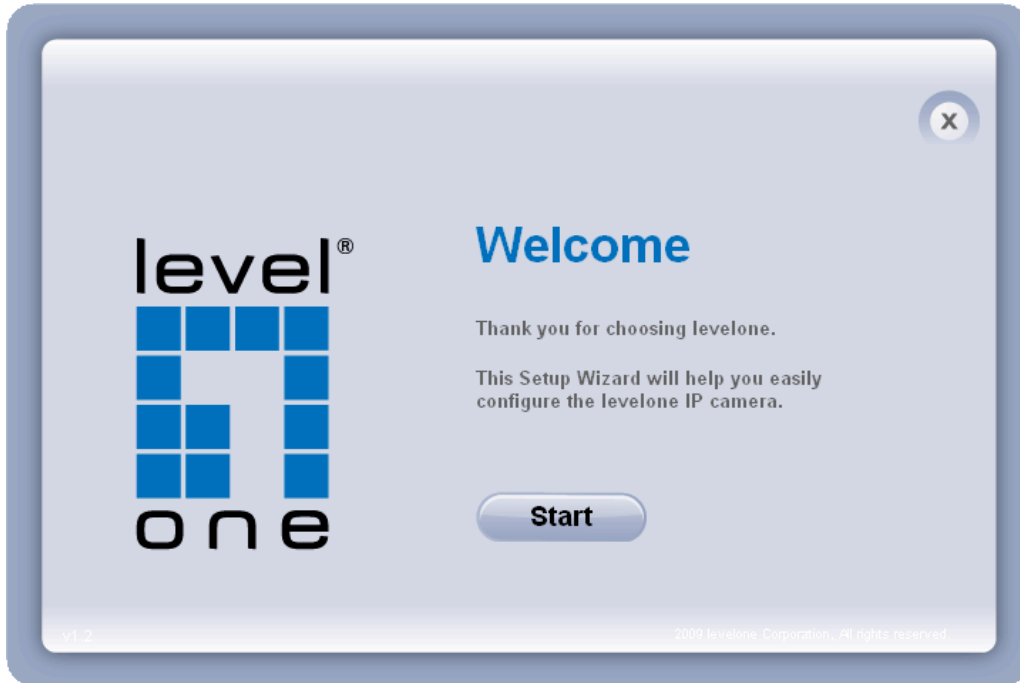

-
3. Select the Network Camera from the survey list and enter the user name and password. The user name and password are assigned as “**admin/admin**”.



4. Setting the Network Camera IP address

User can either select simple mode or professional mode for network camera IP setting. If simple mode is selected, the easy configuration program will set up the connection automatically. If professional mode is selected, the user will need to configure the IP manually, The DHCP setting is recommended. If user wants to set IP address manually, please refer to the product user manual.

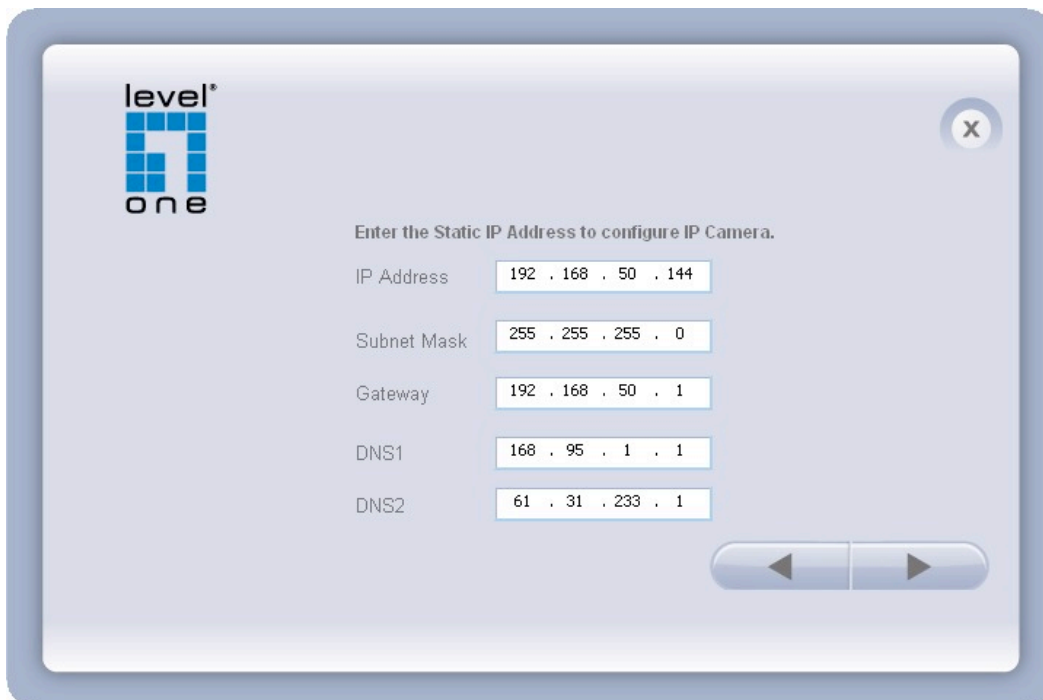
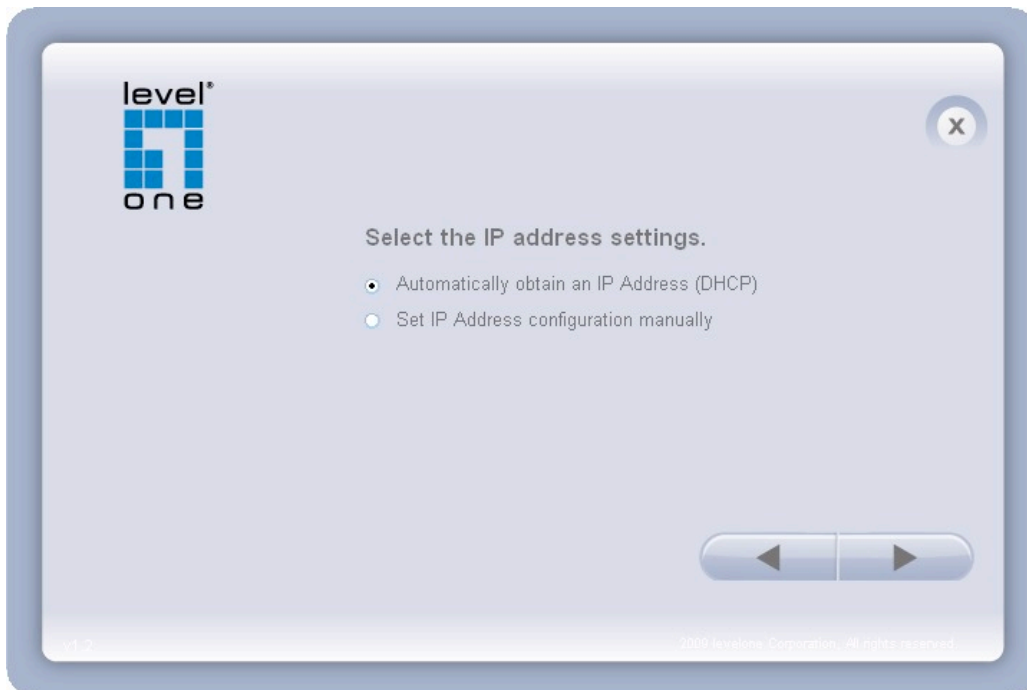

-
5. Please make sure the internet connection is ready then start to do the internet discovery, otherwise click “Skip” to finish the setting.
The default domain name is MAC address; you can also register with your own name on-line.



6. After finish setting, the connection successful or fail showed. If connection failed, user can either try again or quit the installation. User can either select “Run PC-NVR” or "Start Web GUI" to continue or click “X” on the top right of the screen to finish the installation.

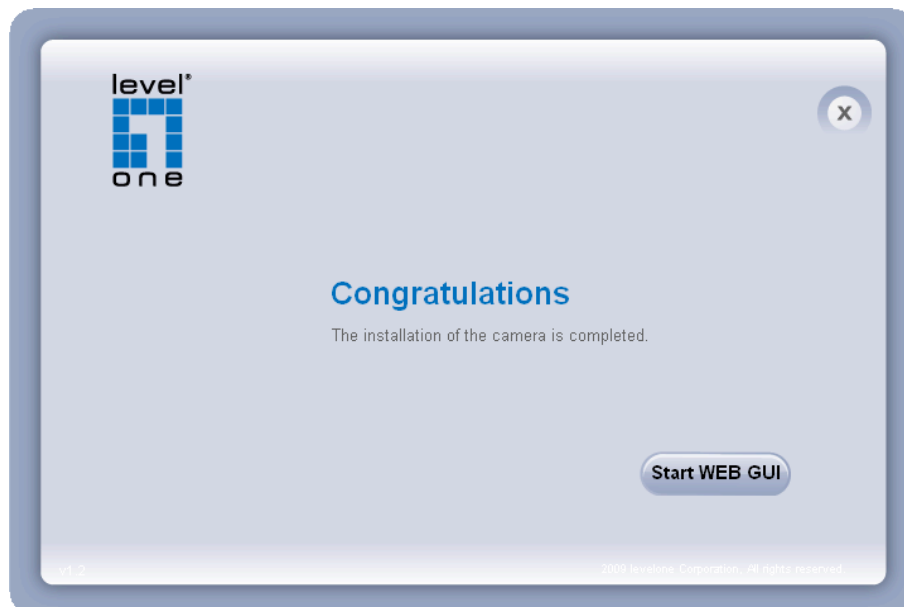

Once installation is completed, the Administrator should proceed to the next section "Access to the Network Camera" for necessary checks and configurations.

Access to the Network Camera

Check Network Settings

The Network Camera can be connected either before or immediately after software installation onto the Local Area Network. The Administrator should complete the network settings on the configuration page, including the correct subnet mask and IP address of gateway and DNS. Ask your network administrator or Internet service provider for the detail information.

Add Password to prevent Unauthorized Access

The Administrator should immediately implement a new password as a matter of prudent security practice. The user name and password for the Administrator are assigned as “**admin/admin**”. Once the Administrator’s password is saved, the Network Camera will ask for the user’s name and password before each access. The Administrator can set up a maximum of ten (10) user accounts. Each user can access the Network Camera except to perform system configuration. Once the password is changed, the browser will display an authentication window to ask for the new password. **Once the password is set, there is no provision to recover the Administrator’s password. The only option is to restore to the original factory default settings.**

Authentication

After opening the Web browser and typing in the URL of the Network Camera, a dialogue window pops up to request a username and password. The user name and password for the Administrator are assigned as “**admin/admin**”. Upon successful authentication, the following figure is displayed.

The foreground is the login window and the background shows the message if authentication fails. The user may check the option box to save the password for future convenience. This option is not available to the Administrator for obvious reason.

Installing plug-in

For the initial access to the Network Camera in Windows, the web browser may prompt for permission to install a new plug-in for the Network Camera on the Internet Explorer. Permission request depends on the Internet security settings of the user’s PC or notebook. If the highest security level is set, the computer may prohibit any installation and execution attempt. This plug-in has been registered for certificate and is used to display the video in the browser. Users may click on  to proceed. If the web browser does not allow the user to continue to install, check the Internet security option and lower the security levels or contact your IT or networking supervisor for help.

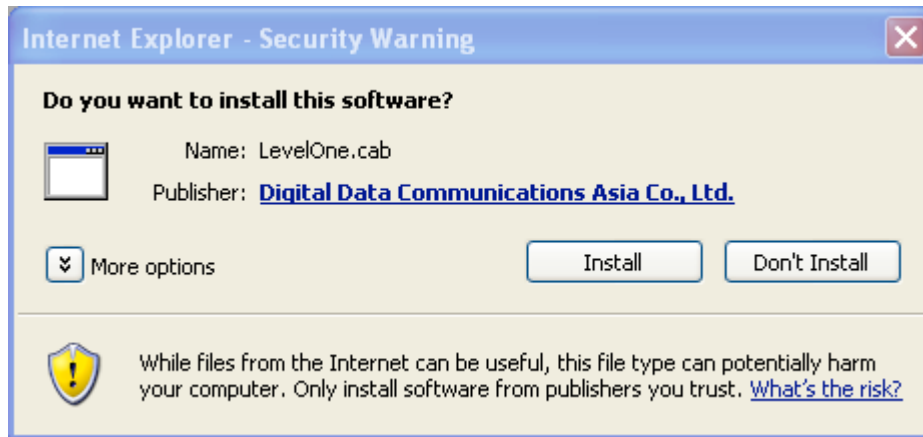

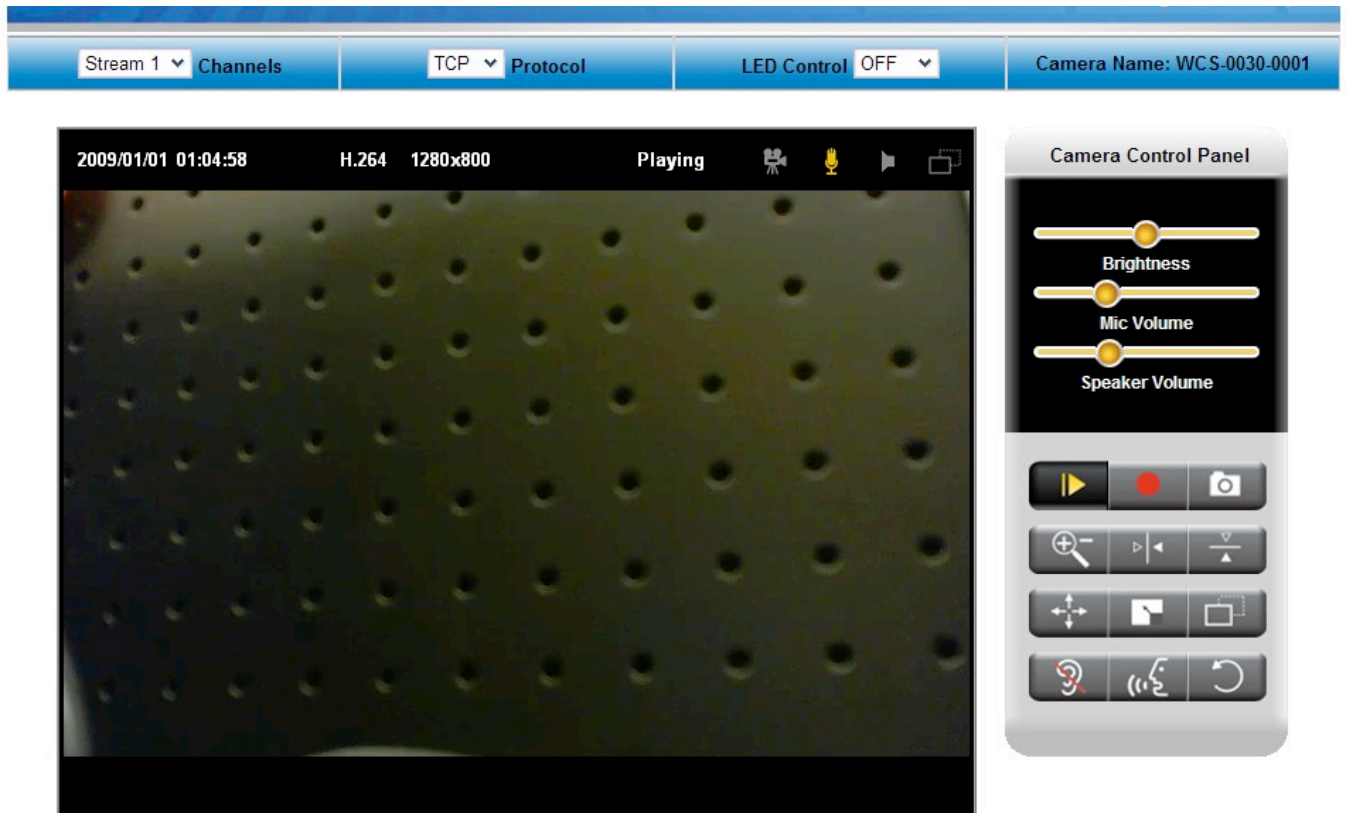

Live View is the default page that opens when accessing the Network Camera. Live video is displayed directly in the browser window.

- **Stream1/Stream2 Channels**

The network camera offers simultaneous dual stream for optimized quality and bandwidth. To configure the codec compression and video resolution, please go to the Configuration->Camera/video/audio->Video to make the changes, or refer to the Video configuration page.

- **TCP/UDP protocol**

TCP - This protocol guarantees the complete delivery of streaming data and thus provides

better video quality. Nevertheless, the downside with this protocol is that its real-time effect is not as good as that of the UDP protocol.

UDP - This protocol allows for more real-time audio and video streams. However, network packets may be lost due to network burst traffic and images may be broken. Activate UDP connection when occasions require time-sensitive responses and the video quality is less important.

LED Control

Select from the drop-down list to adjust the brightness of the camera's LED. Click **Apply** or **Reset** to take effect.



Recording on/off: shows the status of recording video



MIC on /off: shows the status of MIC volume.

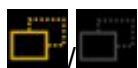

MD on/off: shows the status of Motion Detection

- **Camera Control Panel** - There are two slider bars and eight control buttons on the remote controller. They are describe as below:
- **Brightness and Mic volume adjustment** - Drag the slider bar to adjust the image brightness level and Mic volume. Click “Default” for default brightness setting and “Mute” for no sound. For more Audio setting, please refer to the Audio configuration on page 22.
- **Speaker** –You can output the audio form the computer’s audio input terminal to the camera’s built-in speaker output.



Play or Stop - Click this button to play or stop the video.



Recording - Click this button to record video to your computer.

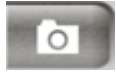

Snapshot - Click this button to capture and save still images.



Digital Zoom - Click this button to enable the zoom operation.

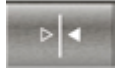

Mirror - horizontally reflect the display of the live video.



Flip - vertically reflect the display of the live video.



Real Size - click this button to view the object in real size. Press this button again to switch back to normal mode.



Full Screen - Click this button to switch to full screen mode. Press “Esc” key to switch back to normal mode.



Motion Detection Alert: Click this button to enable motion detection alert function.



NOTE - The <Video Control Panel> function has no effect on the recorded video. Whatever changes made to the <Video Control Panel> **will not** be applied to the recorded video.

Configuration

Click **Configuration** on the main page to enter the camera setting pages. Note that only Administrators can access the configuration page.

Camera/Video/Audio

Camera

Camera Setting

The screenshot displays the 'Camera Setting' interface. On the left is a video preview window showing a dark scene with a grid of dots and a bright light source. On the right, there are several control panels:

- Brightness**: A slider control.
- Contrast**: A slider control.
- Sharpness**: A slider control.
- Saturation**: A slider control.
- Exposure Control**: Radio buttons for Sport (selected), Normal, Night Vision, AE Lock, and User Defined.
- Mirror and Flip**: Checkboxes for Mirror and Flip.
- Flicker Free**: Radio buttons for 50Hz and 60Hz (selected).
- Color Effect**: Radio buttons for Color (selected) and Black & white.

At the bottom right, there are buttons for 'Test in FullScreen', 'Apply', and 'Reset'.

Camera Setting

Brightness - Drag the slider bar to adjust the image brightness level, which ranges from -5 to +5.

Contrast - Drag the slider bar to adjust the image contrast level, which ranges from -5 to +5.

Sharpness - Drag the slider bar to adjust the image sharpness level, which ranges from -5 to +5.

Saturation - Drag the slider bar to adjust the image saturation level, which ranges from -5 to +5.

Environment - User can look for a place that best suits your needs, either outdoor or indoor.

Flicker-Free - While flicker-free technology eliminates the problem of flicker, it can cause slight judder on fast moving images or blurring problems; fast scrolling text for example may blur.



NOTE - The "Environment" setting adjusts the sampling rate of the camera sensor to achieve Flicker-free effect on the video.

The sampling rate, however, may not work best with the frame rate chosen in the "Video" setting.

For best recording experience, configure your IP camera to one of the following frame rates based on the Environment used:

Environment / Flicker-Free	Frame Rate
-----	-----
Outdoor or Indoor (50Hz)	25, 10, 7, 5, 3, 2
Indoor (60 Hz)	20, 10, 7, 5, 3, 2

Mirror and Flip

Mirror - Enable to horizontally reflect the display of the live video.

Flip - Enable to vertically reflect the display of the live video.

Video

You can set up two separate streams for the Network Camera for different viewing devices.

Stream	Video Overlay	RTSP Server	Save File Folder
Stream 1			
Enabled	<input checked="" type="checkbox"/>		
Video Codec	H.264 ▾		
Video Resolution	1280x800(WXGA) ▾		
Frame Rate	30 fps ▾		
<input checked="" type="radio"/> Quality <input type="radio"/> Bitrate	Not Bad ▾		
Stream 2			
Enabled	<input checked="" type="checkbox"/>		
Video Codec	H.264 ▾		
Video Resolution	640x400(VGA) ▾		
Frame Rate	30 fps ▾		
<input checked="" type="radio"/> Quality <input type="radio"/> Bitrate	Not Bad ▾		
Apply		Reset	

Stream 1 & Stream 2

Video Codec - The Network Camera offers three choices of video codec standards for real-time viewing: H.264, MPEG-4 and MJPEG.

Video Resolution - Select from the drop down list to choose the best resolution that fit your need.

Frame Rate - Select from the drop down list of the frame rate, which ranges from 2 to 30 fps when H.264 or MJPEG is selected. Only 3 to 15 fps can be chosen when MPEG-4 is

selected. Set the frame rate higher for a smoother video quality.

Video quality and bit rate - User can either choose “quality” or “bitrate” to control the video quality with video codec at H.264 or MPEG4. Only “quality” can be chosen when video codec at MJPEG is selected. Set the bitrate higher for a better video quality. However, high bitrate may cost high network bandwidth Resources.

The video qualities are selectable at the following settings: SoSo, OK, Not Bad, Medium, Standard, and Good.

HTTP Transport – Enable to use HTTP protocol for video/audio communication.

Click **Apply** or **Reset** to take effect.

Video Overlay

Stream	Video Overlay	RTSP Server	Save File Folder
The video overlay only takes effect in stream 1			
Timestamp	<input checked="" type="checkbox"/> Enabled		
	Position: <input type="text" value="Left-Top"/>		
Text	<input type="checkbox"/> Enabled		
	Position: <input type="text" value="Left-Top"/>		
	Text: <input type="text"/>		
<input type="button" value="Apply"/>		<input type="button" value="Reset"/>	

Video Overlay - Check to enable the timestamp function and select display position from the drop-down list if user wants date and time to be shown on the screen of the live video. User may also enable and enter the video description in text box; and select display position from the drop-down list if user wants to make a note about the network camera.

Click **Apply** or **Reset** to take effect.



NOTE - The video overlay only takes effect in stream 1.

RTSP Server

RTSP Server	
Port	554
Authentication	DIGEST

Apply Reset

To utilize RTSP authentication, make sure that you have set a password for the Network Camera first.

RTSP (Real-Time Streaming Protocol) controls the delivery of streaming media. By default the port number is set to 554.

Authentication - Depending on your network security requirements, the Network Camera provides two types of security settings for streaming via RTSP protocol: NONE and DIGEST. If DIGEST authentication is selected, user credentials are encrypted using MD5 algorithm, thus providing better protection against unauthorized access.

Save file folder

Save File Folder	
Recording Folder Path:	C:\Documents and Settings\mark hsiao\My Documents\LevelOne
Snapshot Folder Path:	C:\Documents and Settings\mark hsiao\My Documents\LevelOne

Apply Reset

Recording folder path - The destination for saving the recording video files. Click browse to specify the saving path.

Snapshot folder path - The destination for saving the snapshot files. Click browse to specify the saving path.

Click **Apply** or **Reset** to take effect.

Audio

You can set up two separate streams for the Network Camera for different viewing devices. User can either enable or disable the audio function. If audio enable is selected, select the Audio codec from the drop down list.

Audio Configuration

The screenshot shows the 'Audio Configuration' interface. At the top, there are two tabs: 'Stream' (selected) and 'Advanced Settings'. Below the tabs, there are two sections for 'Stream 1' and 'Stream 2'. Each section has a table with two rows: 'Enabled' and 'Audio Codec'. For Stream 1, 'Enabled' is checked and 'Audio Codec' is set to 'G.711'. For Stream 2, 'Enabled' is checked and 'Audio Codec' is set to 'G.711'. At the bottom of the interface, there are two buttons: 'Apply' and 'Reset'.

Stream 1	
Enabled	<input checked="" type="checkbox"/>
Audio Codec	G.711

Stream 2	
Enabled	<input checked="" type="checkbox"/>
Audio Codec	G.711

Apply Reset

Advanced

The screenshot shows the 'Advanced' settings interface. At the top, there are three tabs: 'Stream 1', 'Stream 2', and 'Advanced' (selected). Below the tabs, there is a table with one row: 'Echo cancellation Enabled'. The checkbox is unchecked. At the bottom of the interface, there are two buttons: 'Apply' and 'Reset'.

Echo cancellation Enabled	<input type="checkbox"/>
---------------------------	--------------------------

Apply Reset

Echo cancellation Enabled: Enable to avoid an echo.

Click **Apply** or **Reset** to take effect.

Multicast

Multicast

Stream 1				
Enabled	<input type="checkbox"/>			
Multicast Address	<input type="text" value="234"/>	<input type="text" value="1"/>	<input type="text" value="2"/>	<input type="text" value="3"/>
Port	<input type="text" value="10000"/>			

Stream 2				
Enabled	<input type="checkbox"/>			
Multicast Address	<input type="text" value="234"/>	<input type="text" value="1"/>	<input type="text" value="2"/>	<input type="text" value="3"/>
Port	<input type="text" value="10004"/>			

Multicast addressing is a network technology for the delivery of information to a group of destinations simultaneously using the most efficient strategy to deliver the messages over each link of the network only once, creating copies only when the links to the multiple destinations split. You can either enable or disable the stream1 or stream2 for the Network Camera. The default value for multicast address and port are 234.1.2.3 and 10000. Use different port number for different stream. Use default value is recommended if you are not sure how to setting.

Click **Apply** or **Reset** to take effect.

Network

IP Setting

This section explains how to configure wired network connection for the Network Camera.

IP Settings

IP Settings

Mode	DHCP ▼
------	--------

IP Settings

IP Settings

Mode	Static IP ▼
IP Address	192 . 168 . 50 . 147
Subnet Mask	255 . 255 . 255 . 0
Default Gateway	192 . 168 . 50 . 1
Primary DNS	168 . 95 . 1 . 1
Secondary DNS	61 . 31 . 233 . 1

Apply Reset

IP Settings

IP Settings	
Mode	<input type="text" value="PPPOE"/>
Username	<input type="text"/>
Password	<input type="text"/>

DHCP - Get IP address automatically. Select this option to obtain an available dynamic IP address assigned by a DHCP server each time the camera is connected to the LAN.

Static IP - Select this option to manually assign a static IP address to the Network Camera. Enter the static IP address, Subnet mask, Default Gateway, Primary and Secondary DNS provided by your ISP.

PPPoE - (Point-to-point over Ethernet): Choose this connection type if you are connected to the Internet via a DSL Line. Note that to utilize this feature, it requires an account provided by your ISP. Enter the user name and password provided by your ISP.

Click **Apply** or **Reset** to take effect.

UPnP

Only UPnP discovery supported. Enable this function to allow the user to search for devices of interest on the network. Enter the UPnP name as you wish to show on the intranet.

UPnP

UPnP	
Enabled	<input checked="" type="checkbox"/>
UPnP Name	WCS-0030-0001

Apply **Reset**

Click **Apply** or **Reset** to take effect.

DDNS (dynamic domain name service)

DynDNS	TZO
Enabled	<input type="checkbox"/>
Username	<input type="text"/>
Password	<input type="text"/>
Hostname	<input type="text"/>

Apply **Reset**

DynDNS - Enable the DDNS service allows your Network Camera, especially when assigned with a dynamic IP address, to have a fixed host and domain name. Note that before utilizing this function; please apply a dynamic domain account first. Enter the username, password and hostname when enabled the DDNS.

Click **Apply** or **Reset** to take effect.

TZO

DynDNS		TZO
Enabled	<input type="checkbox"/>	
E-mail Address	<input type="text"/>	
TZO Password	<input type="text"/>	
Domain Name	<input type="text"/>	

TZO - TZO is one kind of the DDNS providers. User can refer to the [TZO.com](http://www.tzo.com/): visit <http://www.tzo.com/> to apply a dynamic domain account when selecting this DDNS provider.

Enter the e-mail address, password and domain name when enabled the TZO.

Click **Apply** or **Reset** to take effect.

Easy Link

Easy Link	
Enabled	<input checked="" type="checkbox"/>
Domain Name	<input type="text" value="wcs0030"/> .level1dns2.net <input type="button" value="Check Available"/>
Refresh Time	<input type="text" value="1 hr"/> <input type="button" value="Update Now"/>
Status	Disconnected

Easy Link – the IP camera had bundle with free Level1DNS™ service that allows user to remote access the IP camera via internet. The default domain name is MAC address, you can also register your own name on-line but it have to check the available first. The status will show the connection with Level1DNSTM service.

Notice: Please make sure the internet connection is ready first!

Wireless

Basic Settings

Basic Settings	Advance Settings	Wi-Fi Protected Setup
Network Name (SSID)	<input type="text" value="WCS-0030"/>	<input type="button" value="Site survey"/>
Security	<input type="text" value="Disable"/>	
Network Type	<input checked="" type="radio"/> Infrastructure mode <input type="radio"/> Ad-hoc mode	
<input type="button" value="Apply"/>		<input type="button" value="Reset"/>
<input type="button" value="Site survey"/>		
Pressing "Site survey" will update the list.		

Network Name (SSID) - The SSID is the network name shared among all points in a wireless network. The SSID must be identical for all devices in the wireless network. It is case-sensitive and can be up to 32 characters in length. Make sure this setting is the same for all points in your wireless network.

Wireless devices have a default wireless network name or Service Set Identifier (SSID) set by the factory,. Level1 wireless products use **Level1** as the default wireless network name. You should change the wireless network name to something unique to distinguish your wireless network from other wireless networks that may exist around you, but do not use personal information, because this information may be available for anyone to see when browsing for wireless networks.

Security

Encryption protects data transmitted over a wireless network. Wi-Fi Protected Access (WPA-Personal/WPA2-personal) and Wired Equivalent Privacy (WEP) offer different levels of security for wireless communication. A network encrypted with WPA-Personal/WPA2-personal is more secure than a network encrypted with WEP, because WPA-Personal/WPA2-personal uses dynamic key encryption. To protect the information as it passes over the airwaves, you should enable the highest level of encryption supported by your network equipment.

Select the security method for your wireless network. If you do not want to use wireless security, keep the default, **Disabled**.

WEP

WEP is a basic encryption method that is not as secure as WPA.

Basic Settings		Advance Settings		Wi-Fi Protected Setup	
Network Name (SSID)	<input type="text" value="WCS-0030"/>	<input type="button" value="Site survey"/>			
Security	<input type="text" value="WEP"/>				
TX Key:	<input type="text" value="1"/>				
WEP Encryption:	<input type="text" value="40/64 bits (10 hex digits)"/>				
Key 1:	<input type="text"/>				
Key 2:	<input type="text"/>				
Key 3:	<input type="text"/>				
Key 4:	<input type="text"/>				
Authentication:	<input type="text" value="Open System"/>				
Network Type	<input checked="" type="radio"/> Infrastructure mode <input type="radio"/> Ad-hoc mode				
<input type="button" value="Apply"/> <input type="button" value="Reset"/>					
<input type="button" value="Site survey"/>					
Pressing "Site survey" will update the list.					

Tx Key - Select a key from the drop-down menu.

WEP Encryption: Select a level of WEP encryption, 64 bits 10 hex digits or 128 bits 26 hex digits. The default is 64 bits 10 hex digits.

Key 1-4 - Enter the WEP key(s) manually

Authentication Type - The default is set to open system, which allows either Shared Key or Auto authentication to be used. With Open System authentication, the sender and the recipient do NOT use a WEP key for authentication. With Shared Key authentication, the sender and recipient use a WEP key for authentication.

Network Type - Select Infrastructure if your network consists of both wired and wireless devices that communicate through a central device, such as an access point. Select Ad-hoc if your network consists of only wireless devices that communicate with each other directly.

Click Apply or Reset to take effect.

Site Survey

SSID Broadcast, when wireless clients survey the local area for wireless networks to associate with, they will detect the SSID broadcast of the camera.

WPA-Personal

Wireless Configuration

Basic Settings	Advanced Settings	Wi-Fi Protected Setup
Network Name (SSID)	<input type="text" value="LevelOne"/>	<input type="button" value="Site survey"/>
Network Type	<input checked="" type="radio"/> Infrastructure mode <input type="radio"/> Ad-hoc mode	
Security	<input type="text" value="WPA-Personal"/>	
Encryption	<input type="text" value="TKIP"/>	
Shared Key	<input type="text" value=""/>	(8 to 63 characters)
<input type="button" value="Apply"/>		<input type="button" value="Reset"/>
<input type="button" value="Site survey"/>		
Click the Site Survey button to update the list.		

WPA supports two encryption methods, TKIP and AES, with dynamic encryption keys. Select the type of algorithm, TKIP or AES. The default is TKIP.

Shared Key - Enter the key shared between the Router and the server keys. Enter a passphrase of 8-63 characters.

Network Type - Select Infrastructure if your network consists of both wired and wireless devices that communicate through a central device, such as an access point. Select Ad-hoc if your network consists of only wireless devices that communicate with each other directly.

Click **Apply** or **Reset** to take effect.

WPA2-Personal

Basic Settings	Advanced Settings	Wi-Fi Protected Setup
Network Name (SSID)	<input type="text" value="LevelOne"/>	<input type="button" value="Site survey"/>
Network Type	<input checked="" type="radio"/> Infrastructure mode <input type="radio"/> Ad-hoc mode	
Security	WPA2-Personal ▼	
Encryption	AES ▼	
Shared Key	<input type="text"/> (8 to 63 characters)	
<input type="button" value="Apply"/> <input type="button" value="Reset"/>		
Site Survey List		
Click the Site Survey Button to update the list.		

WPA2 supports AES encryption methods with dynamic encryption keys.

Shared Key - Enter the key shared between the Router and the server keys. Enter a pass phrase of 8-63 characters.

NOTE: If you are using WPA or WPA2, each device in your wireless network MUST use the same WPA or WPA2 method and shared key, or else the network will not function properly.

Advanced Settings

Wireless Configuration

Basic Settings	Advanced Settings	Wi-Fi Protected Setup
Network Mode	Mixed ▼	
Radio Band	Auto-20/40MHz Channel ▼	
Enable WMM (802.1e QoS)	<input type="radio"/> Enabled <input checked="" type="radio"/> Disabled	
<input type="button" value="Apply"/> <input type="button" value="Reset"/>		

Network Mode - From this drop-down menu, you can select the wireless standards running on your network. If you have both Wireless-B, Wireless-G and Wireless-N (2.4GHz) devices in your network, keep the default setting, **Mixed**. If you have both Wireless-B, Wireless-G devices in your network, select **BG-Mixed**. If you have only Wireless-B devices, select **Wireless-B Only**. If you have only Wireless-G devices, select **Wireless-G Only**. If you have only Wireless-N (2.4GHz) devices, select **Wireless-N Only**.

Radio Band - The settings are available for the Auto-20/40MHz channel and Standard-20 MHz channel. The Auto-20/40MHz channel set up a network using the 20/40MHz band, and the Standard-20 MHz channel set up a network using the 20 MHz band.

Enable WMM (802.1e QoS) - WMM is a wireless Quality of Service feature that improves quality for audio, video, and voice applications by prioritizing wireless traffic. To use this feature, your wireless client devices in your network must support Wireless WMM. If you would like to disable this feature, select **Disabled**. Otherwise, keep the default, **Enabled**.

Wi-Fi Protected Setup

Wireless Configuration

Basic Settings	Advanced Settings	Wi-Fi Protected Setup
PIN MODE Enter PIN number <input type="text" value="0"/> in your AP device. And enter your AP's SSID!! <input type="text" value="LevelOne"/>		
Wi-Fi Protected Status Not Configured		
<input type="button" value="Apply"/>		<input type="button" value="Reset"/>

Use this method if your client device has a Wi-Fi Protected Setup PIN number.

1. Enter the PIN number and SSID from the device in the field on the screen.

Click **Apply** or **Reset** to take effect.

HTTP/HTTPS

HTTP/HTTPS	
HTTP	
Enabled	<input checked="" type="checkbox"/>
Port	<input type="text" value="80"/>
HTTPS	
Enabled	<input type="checkbox"/>
Port	<input type="text" value="443"/>

HTTP - This protocol allows the same quality as TCP protocol without needing to open specific ports for streaming under some network environments. Users inside a firewall can utilize this protocol to allow streaming data through.

HTTPS - (Hypertext Transfer Protocol over SSL): This section explains how to enable authentication and encrypted communication over SSL (Secure Socket Layer). It helps protect streaming data transmission over the Internet on higher security level.

Click to enable and click **Apply** or **Reset** to take effect.

Event

Motion Detection

Motion can be detected by measuring change in speed or vector of an object or objects in the field of view. This section explains how to configure the Network Camera to enable motion detection. There are three motion detection windows can be configured.

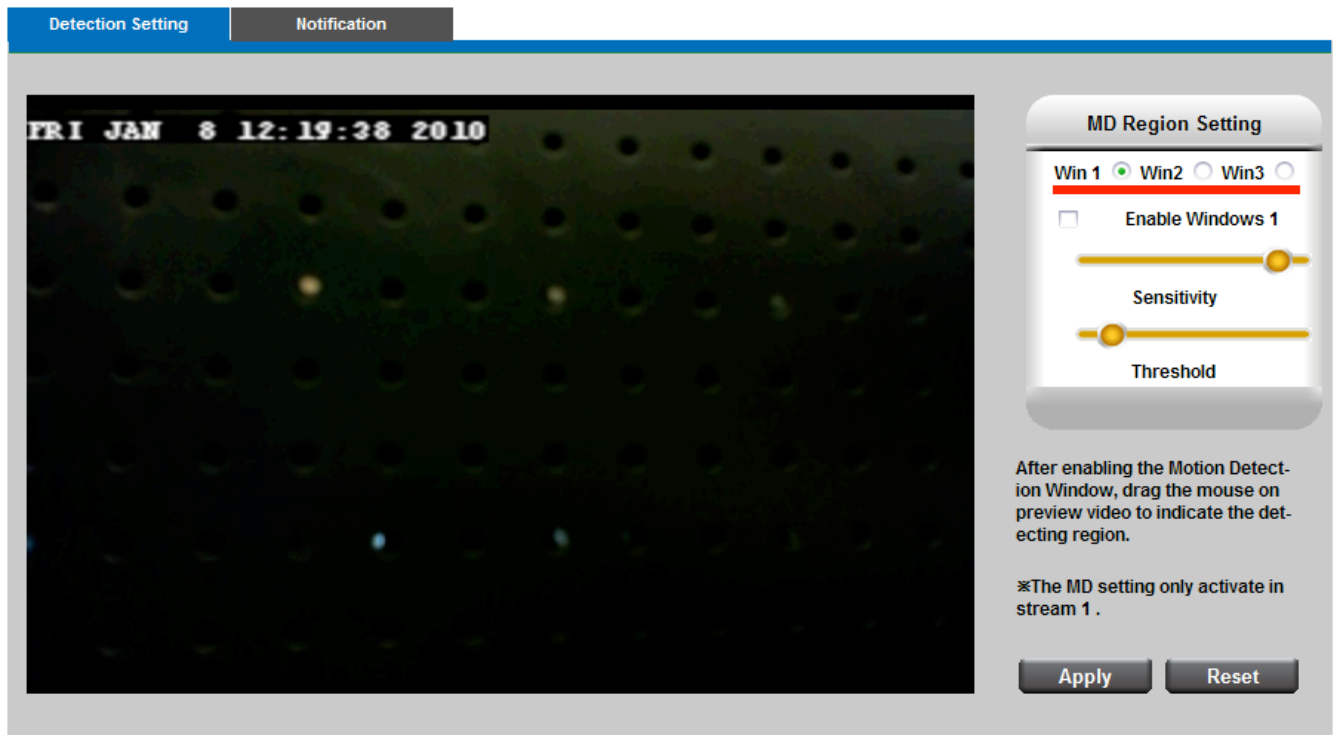

Detection Setting - Select and enable the motion detection windows function. Easier to trigger event by higher the sensitivity value and lower the Threshold value.

Notification - To react in response to particular events. A typical application is that when a motion is detected, the Network Camera sends buffered images to a FTP server, Samba, SMTP or HTTP as notifications. In this page, you can specify which notification messages will be sent when a trigger is activated. You can configure the Network Camera to send video streaming URL or video clips to your email address or FTP site.

Click **Apply** or **Reset** to take effect.

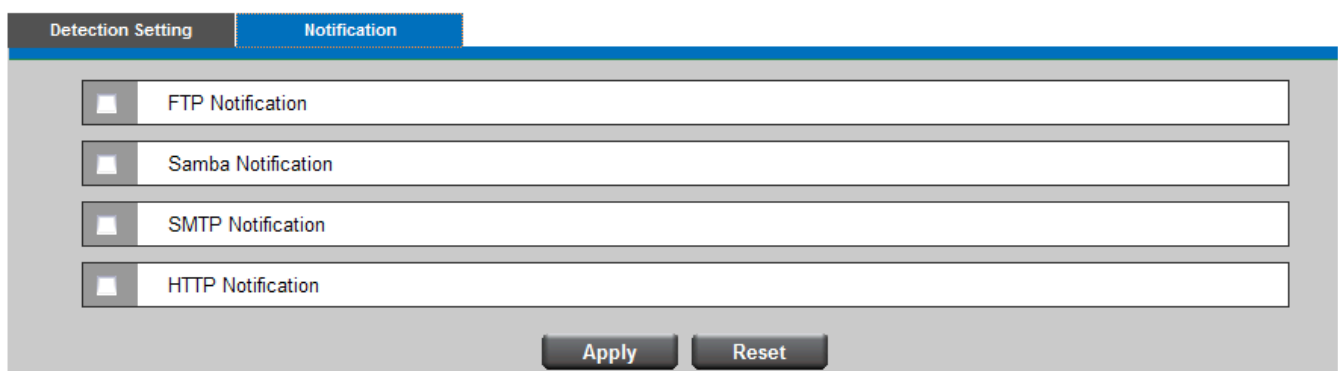

Notification setting

When an event is triggered, you can specify what kind of action will be performed. You can

attach video clip to your email address, FTP site, samba or HTTP.

FTP - File Transfer Protocol (FTP) is often used as an application component to automatically transfer files for program internal functions. Select to send the media files to a FTP server when a trigger is activated. Enter the FTP IP address or hostname; by default, the FTP port server is set to 21, enter account name and password to configure the setting.

FTP	SMTP	Samba	HTTP
Server Selection	Primary FTP Server		
FTP Address	IP Address 0 . 0 . 0 . 0		
FTP Port	21		
Account Name			
Account Password			
Attachment	<input type="radio"/> Video Clip <input checked="" type="radio"/> Snapshot		

Apply **Reset**

Click **Apply** or **Reset** to take effect.

SMTP - Select to send the media files via Email when a trigger is activated.

From - Enter the email address of the sender.

To - Enter the email address of the recipient. Many recipients are separated by commas.

My name - The title shown in the email.

Subject - Enter the subject of the email.

Attached - There are two choices of media types available: video streaming URL and video clip.

SMTP Server and port number - Enter the server host name and port number of the email server.

Authentication - Select the authentication type from the drop-down list.

Email Account - Enter the user name of the email account if necessary.

Email Password - Enter the password of the email account if necessary.

FTP	SMTP	Samba	HTTP
From	<input type="text"/>		
To	<input type="text"/>		
CC	<input type="text"/>		
My Name	<input type="text"/>		
Subject	<input type="text"/>		
Attachment	<input type="radio"/> Video Clip <input checked="" type="radio"/> Snapshot		
Server Selection	Primary Email Server <input type="button" value="v"/>		
SMTP Server	<input type="text"/>		
SMTP Port	25 <input type="text"/>		
Authentication	LOGIN <input type="button" value="v"/>		
Email Account	<input type="text"/>		
Email Password	<input type="text"/>		

Click **Apply** or **Reset** to take effect.

Samba - Select to send the network file system media files via network neighborhood when a trigger is activated.

IP Address - Enter the IP address of the samba server.

User Name - Enter the user name of the samba server.

Password - Enter the password of the samba server.

Workgroup - Enter the workgroup of the samba server.

Share DIR - Enter the share DIR of the samba server.

FTP	SMTP	Samba	HTTP
Server Address	IP Address ▾ 0 . 0 . 0 . 0		
User Name	<input type="text"/>		
Password	<input type="text"/>		
WorkGroup	<input type="text"/>		
Share DIR	<input type="text"/>		
Attachment	<input checked="" type="radio"/> Video Clip <input type="radio"/> Snapshot		
Apply		Reset	

Click **Apply** or **Reset** to take effect.

HTTP - Select to send the media files to a HTTP server when a trigger is activated.

FTP	SMTP	Samba	HTTP
URL	<input type="text"/>		
Message	<input type="text"/>		
User Name	<input type="text"/>		
Password	<input type="text"/>		
Apply		Reset	

URL - Enter the URL of the HTTP server.

Message: Enter the message that informs you when a trigger is activated.

Scheduled Event

The screenshot shows a web interface for managing scheduled events. At the top, there is a blue header with the word "Event". Below it is a grey box containing a table titled "Schedule". The table has columns for "Enabled", "Name", "Event", "Start", "End", "Date", and "Action". The table is currently empty, with the text "The schedule is empty!" centered below the header row. Below the table is a dark grey button labeled "New".

Click **New** to open the recording setting page. In this page, you can define the recording schedule and recording capacity.

The screenshot shows the recording setting page. It has a blue header with "Event". Below it is a grey box containing a table titled "Schedule" with columns "Enabled", "Name", "Event", "Start", "End", "Date", and "Action". The table is empty with "The schedule is empty!" below it. Below the table is a form with the following fields: "Enabled" with a checkbox, "Name" with a text input, "Event" with a dropdown menu showing "Record", "Times" with "Start" and "End" time pickers (each with hour and minute dropdowns), and "Date" with checkboxes for Sun, Mon, Tue, Wed, Thu, Fri, and Sat. To the right of the form are two buttons: "Add" and "Cancel".

Name - Enter a descriptive name for the recording setting.

Event - Select from the drop-down menu for the recording or rebooting event.

Time - Specify the recording duration.

- Select the time for recording in 24-hr time format. End time must be more than start time.
- Select the days on weekly basis.

When completed, Click Add to have recording name appears in the recording list on the recording page. Select **Enabled**; the system begins recording and send recorded file to the Network Storage. To **edit** a recording setting; click Edit to modify. Upon the completion, click update to finish the modification. To remove a recording setting from the list, select a recording name from the list and then click **Delete**. Click New to add more events.

PIR

PIR Setting	Notification
Enabled	<input type="checkbox"/>
Sensitivity	50 %
<input type="button" value="Apply"/> <input type="button" value="Reset"/>	

Enable PIR sensor to detect a moving infrared object such as a person in the dark.

Sensitivity - is used to adjust the sensitivity of the PIR Sensor from 10 - 100%. The default sensitivity is 50%.

By increasing the sensitivity, the range of the PIR Sensor is also increased. The PIR Sensor can be configured to detect movement in the dark up a maximum range of 6 meters. Select from the drop-down list to adjust the PIR Sensor's sensitivity.

PIR Setting	Notification
LED control	<input checked="" type="radio"/> Keep active during event <input type="radio"/> Keep active for <input type="text" value="0"/> Sec
Light	Activate <input type="text" value="On"/> Inactivate <input type="text" value="OFF"/>
<input type="button" value="Apply"/> <input type="button" value="Reset"/>	

Notification

Light - to illuminate the scene. The brightness of light source can be manually selected from the drop-down list.

Click **Apply** or **Reset** to take effect.

System

System Log

Log - To send a system log to the network camera when a trigger is activated.

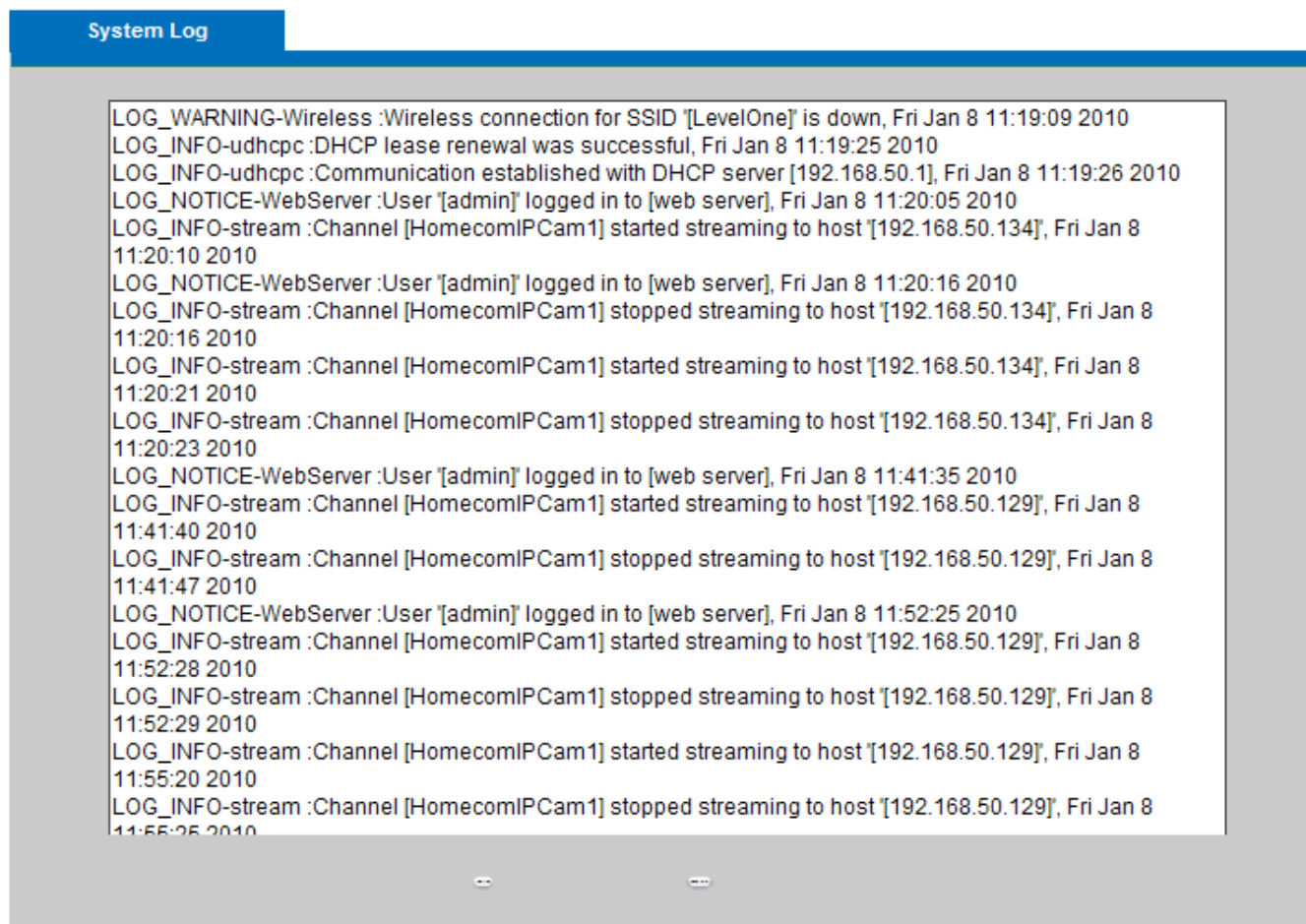

The screenshot shows a window titled "System Log" with a blue header. Below the header is a white box containing a list of log entries. The entries are as follows:

```
LOG_WARNING-Wireless :Wireless connection for SSID "[LevelOne]" is down, Fri Jan 8 11:19:09 2010
LOG_INFO-udhcpd :DHCP lease renewal was successful, Fri Jan 8 11:19:25 2010
LOG_INFO-udhcpd :Communication established with DHCP server [192.168.50.1], Fri Jan 8 11:19:26 2010
LOG_NOTICE-WebServer :User [admin] logged in to [web server], Fri Jan 8 11:20:05 2010
LOG_INFO-stream :Channel [HomecomIPCam1] started streaming to host "[192.168.50.134]", Fri Jan 8
11:20:10 2010
LOG_NOTICE-WebServer :User [admin] logged in to [web server], Fri Jan 8 11:20:16 2010
LOG_INFO-stream :Channel [HomecomIPCam1] stopped streaming to host "[192.168.50.134]", Fri Jan 8
11:20:16 2010
LOG_INFO-stream :Channel [HomecomIPCam1] started streaming to host "[192.168.50.134]", Fri Jan 8
11:20:21 2010
LOG_INFO-stream :Channel [HomecomIPCam1] stopped streaming to host "[192.168.50.134]", Fri Jan 8
11:20:23 2010
LOG_NOTICE-WebServer :User [admin] logged in to [web server], Fri Jan 8 11:41:35 2010
LOG_INFO-stream :Channel [HomecomIPCam1] started streaming to host "[192.168.50.129]", Fri Jan 8
11:41:40 2010
LOG_INFO-stream :Channel [HomecomIPCam1] stopped streaming to host "[192.168.50.129]", Fri Jan 8
11:41:47 2010
LOG_NOTICE-WebServer :User [admin] logged in to [web server], Fri Jan 8 11:52:25 2010
LOG_INFO-stream :Channel [HomecomIPCam1] started streaming to host "[192.168.50.129]", Fri Jan 8
11:52:28 2010
LOG_INFO-stream :Channel [HomecomIPCam1] stopped streaming to host "[192.168.50.129]", Fri Jan 8
11:52:29 2010
LOG_INFO-stream :Channel [HomecomIPCam1] started streaming to host "[192.168.50.129]", Fri Jan 8
11:55:20 2010
LOG_INFO-stream :Channel [HomecomIPCam1] stopped streaming to host "[192.168.50.129]", Fri Jan 8
11:55:25 2010
```

At the bottom of the white box, there are two small icons: a minus sign and a plus sign.

This page displays the system's log in chronological order. The system log is stored in the Network Camera's buffer area and will be overwritten when reaching a certain amount.

Click **Retrieve** to retrieve the log, or click **Save to file** to save the file in the specify location.

Date & Time Settings

Manual - The user enters the date and time manually.

Clone from PC - Sync with computer time; click clone to synchronize the date and time of the Network Camera with the local computer. The read-only date and time of the PC is displayed as updated.

Date and Time

<input type="radio"/>	Manual	Year	<input type="text" value="2010"/>	Month	<input type="text" value="1"/>	Day	<input type="text" value="8"/>	Hour	<input type="text" value="11"/>	Minute	<input type="text" value="19"/>	Second	<input type="text" value="1"/>
<input checked="" type="radio"/>	Clone from PC	Year	<input type="text" value="2010"/>	Month	<input type="text" value="1"/>	Day	<input type="text" value="15"/>	Hour	<input type="text" value="11"/>	Minute	<input type="text" value="23"/>	Second	<input type="text" value="45"/>
		<input type="checkbox"/>	Clone										

<input checked="" type="radio"/>	NTP	TimeZone	<input type="text" value="(GMT+8)HONG KONG"/>
		NTP Server 1	<input type="text" value="tick.stdtime.gov.tw"/>
		NTP Server 2	<input type="text" value="clock.stdtime.gov.tw"/>
		Daylight Saving	<input type="checkbox"/> Enabled

NTP - Select to update the time with the NTP server on hourly, daily, weekly, or monthly basis.

Time Zone - According to your local time zone, select one from the drop-down list.

NTP Server 1 and Server 2 - Enter the address of the NTP server.

Daylight Saving: Enable this option to retain the Daylight Saving Time changes automatically.

Click **Apply** or **Reset** to take effect.

Device Information

Video/Audio Setting - To view the entire video/audio setting information about the network camera.

System Information	Network Settings	Video/Audio Settings
Lan MAC Address	00:11:6b:ab:ba:12	
Wireless MAC Address	00:92:12:33:33:55	
Firmware Version	v1.0.1.13	
Firmware Release	01/11/2010	
Product Name	WCS-0030	
Model Number	0030	
Company Name	Level One	
Comments	Wireless H.264 MegaPixel PIR Lighting IP Camera	
UPnP Name	WCS-0030-ba12	

Network Setting - To view the entire network setting information about the network camera.

System Information	Network Settings	Video/Audio Settings
IP Setting Type	DHCP	
IP Address	192.168.50.163	
Subnet Mask	255.255.255.0	
Default Gateway	192.168.50.1	
Primary DNS	168.95.1.1	
Secondary DNS	61.31.233.1	
UPnP	Enabled	
DynDNS	Disabled	
TZO	Disabled	

System Information - To view the entire system information about the network camera.

System Information		Network Settings		Video/Audio Settings	
Stream 1					
Video Codec	H264				
Video Resolution	320x192(QVGA)				
Video Frame Rate	10 fps				
Video Bitrate	512 Kbps				
Audio Codec	G.711				
Multicast IP	N/A				
Stream 2					
Video Codec	MJPEG				
Video Resolution	1280x800(WXGA)				
Video Frame Rate	25 fps				
Video Quality	Not Bad				
Audio Codec	N/A				
Multicast IP	N/A				

Storage Management - To view the entire recorded files in SD card.

Storage Management		Advanced Settings			
Local Storage Information					
Total Capacity	0MB				
Used Size	0MB				
Available Size	0MB				
Storage Management					
Filename ▲	Size	Time	Delete	Download	
Reload					

Click **Remove** to safely remove the storage device.

Click **Reload** to view the list.

Maintenance

User Management

This section explains how to enable password protection and create multiple accounts.

Privilege Setting - Enter the new user's name and password. Select the privilege for new user account. Click **Add** to take effect. The administrator account name is "admin", which is permanent and can not be deleted.

Access rights are sorted as following (Viewer, Administrator and Remote Viewer). Only administrators can access the Configuration page. Viewers can access the main page for live viewing only. The privilege of Remote Viewer is same as viewer except TCP protocol can only be selected for live viewing page. Administrators can add up to 10 user accounts. Administrator also can change user's access rights or delete user accounts. Select an existing account to modify and make necessary changes; then click **Update** or **Delete** to take effect.

Privilege Setting

Index	User Name	Password	Confirm Password	Privilege	Action		
1	admin	•••••	•••••	Administrator ▾	Add	Delete	Update
2	<input type="text"/>	<input type="password"/>	<input type="password"/>	Viewer ▾	Add	Delete	Update
3	<input type="text"/>	<input type="password"/>	<input type="password"/>	Viewer ▾	Add	Delete	Update
4	<input type="text"/>	<input type="password"/>	<input type="password"/>	Viewer ▾	Add	Delete	Update
5	<input type="text"/>	<input type="password"/>	<input type="password"/>	Viewer ▾	Add	Delete	Update
6	<input type="text"/>	<input type="password"/>	<input type="password"/>	Viewer ▾	Add	Delete	Update
7	<input type="text"/>	<input type="password"/>	<input type="password"/>	Viewer ▾	Add	Delete	Update
8	<input type="text"/>	<input type="password"/>	<input type="password"/>	Viewer ▾	Add	Delete	Update
9	<input type="text"/>	<input type="password"/>	<input type="password"/>	Viewer ▾	Add	Delete	Update
10	<input type="text"/>	<input type="password"/>	<input type="password"/>	Viewer ▾	Add	Delete	Update

IP Filter

IP Filter - Enable the IP filter and set of allow or deny IP address range to server. Click

Add to list to add the IP range to the IP filter list.

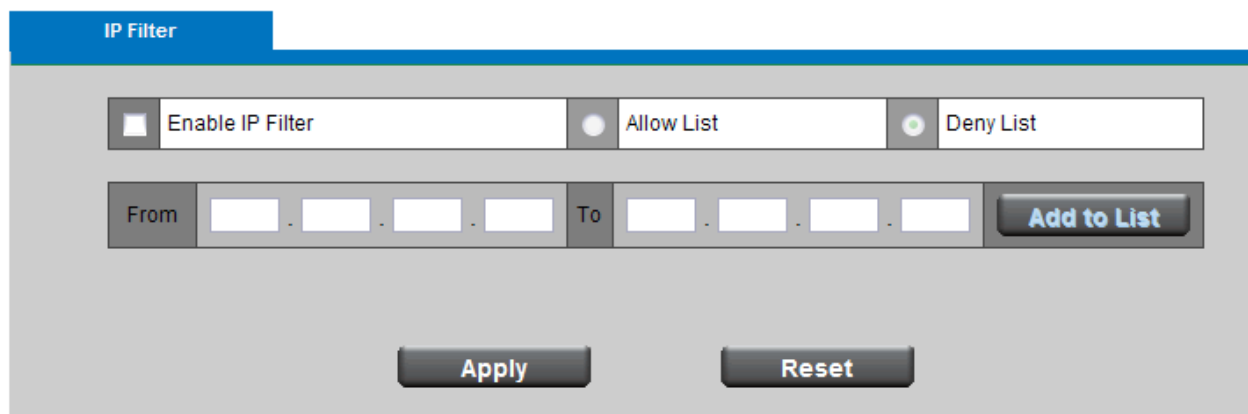

The screenshot shows the 'IP Filter' configuration page. At the top, there is a blue header with the text 'IP Filter'. Below the header, there are three radio button options: 'Enable IP Filter' (which is selected), 'Allow List', and 'Deny List'. Underneath these options, there are two IP address input fields labeled 'From' and 'To', each consisting of four boxes separated by dots. To the right of the 'To' field is a dark button labeled 'Add to List'. At the bottom of the form, there are two dark buttons labeled 'Apply' and 'Reset'.

Click **Apply** or **Reset** to take effect.

Firmware Upgrade

This feature allows you to upgrade the firmware on your Network Camera. It takes about few minutes to complete the process. Note that do not power off the Network Camera during the upgrade.

Upgrade - Click **Browse...** and specify the firmware file. Click **Upgrade**. The Network Camera starts to upgrade and will reboot automatically when the upgrade completes.

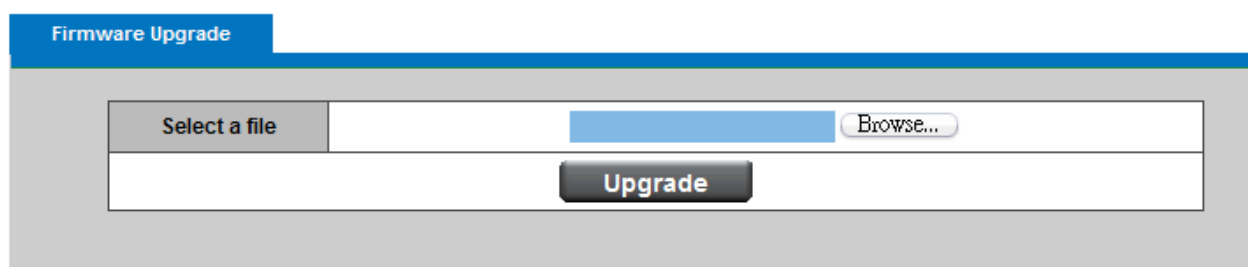

The screenshot shows the 'Firmware Upgrade' configuration page. At the top, there is a blue header with the text 'Firmware Upgrade'. Below the header, there is a file selection area with a text box containing 'Select a file' and a 'Browse...' button. Below this area is a large dark button labeled 'Upgrade'.

Configuration

This feature allows you to export/import the configuration files of the network camera.

Import/Export - Click **export** to pop up a dialog to indicate the location and file to export.

Click **browse** to indicate the location and file of the camera configuration and click **import** to import the configuration file back into the network camera.

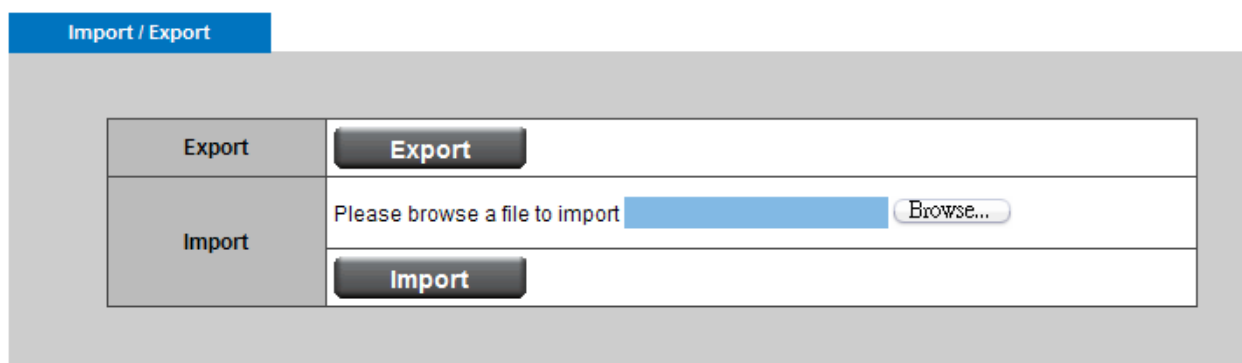

The screenshot shows a web interface with a blue header bar labeled "Import / Export". Below the header is a table with two rows. The first row is for "Export" and contains a dark grey button labeled "Export". The second row is for "Import" and contains the text "Please browse a file to import" followed by a blue input field and a light blue button labeled "Browse...". Below the input field is a dark grey button labeled "Import".

Reset to default

Reset to default - Click **Reset** to restore the network camera to factory default setting.

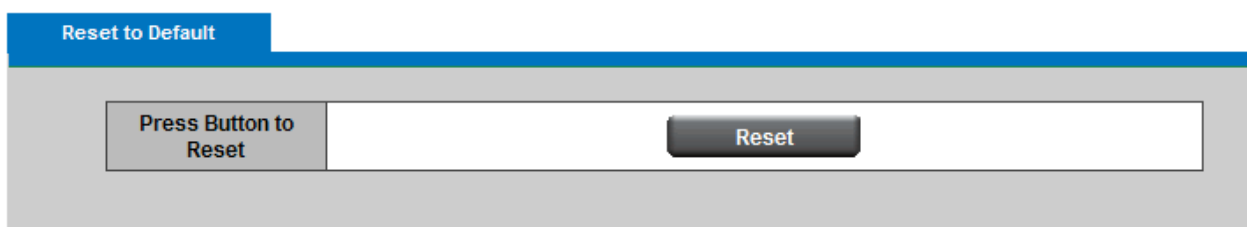

The screenshot shows a web interface with a blue header bar labeled "Reset to Default". Below the header is a table with two columns. The first column contains the text "Press Button to Reset". The second column contains a dark grey button labeled "Reset".

Reboot



The screenshot shows a web interface with a blue header bar labeled "Reboot". Below the header is a table with two columns. The first column contains the text "Press Button to Reboot". The second column contains a dark grey button labeled "Reboot".

This feature allows you to reboot the Network Camera, which takes about one minute to complete. When completed, the live video page will be displayed in your browser. The following message will show during the rebooting process.

